

POLARIS SPORTSMAN

2022

ACCESSORIES + APPAREL



FORGE YOUR OWN PATH



The ATV that defined the industry, SPORTSMAN combines legendary smoothness, unstoppable versatility and an ease of use that the competition continues to chase, which is why SPORTSMAN is chosen by more ATV owners. Whether you're tearing up the trails, working out in the fields, or navigating the wilderness for the perfect hunt, there is a SPORTSMAN story to be told.

2022 LINEUP

570 P. 14

RECREATION & UTILITY



SPORTSMAN 570 (EPS/EBS)

TOURING



SPORTSMAN TOURING 570 (EPS/EBS)

WORK



SPORTSMAN 570 6X6



SPORTSMAN 570 X2

SPECIAL EDITION



SPORTSMAN 570 AGRI PRO



SPORTSMAN 570 HUNTER



SPORTSMAN 570 BLACK LE



SPORTSMAN 570 OHLINS



SPORTSMAN X2 570 NORDIC PRO

XP 1000 / XP 1000 S P. 26

RECREATION & UTILITY



SPORTSMAN XP 1000



SPORTSMAN XP 1000 S

TOURING



SPORTSMAN TOURING XP 1000

SCRAMBLER P. 34



SCRAMBLER XP 1000



SCRAMBLER XP 1000 S

YOUTH P. 36



OUTLAW 70

CONTENTS

MODEL YEAR 2022	02
WINCHES	10
570	12
WINCHES, PROTECTION & RACKS	14
COMFORT, AUDIO & STORAGE	16
WINDSHIELDS	18
570 6X6, 570 TOURING & 570 X2	20
2014-2020 MODELS	22
XP 1000 / XP 1000 S	24
WINCHES, RACKS & PROTECTION	26
STORAGE, AUDIO & COMFORT	28
WINDSHIELDS	30
SCRAMBLER XP 1000 S	32
YOUTH: OUTLAW 70 EFI	34
COMMON ACCESSORIES	36
GLACIER PLOW SYSTEMS	36
TRACKS	38
WHEELS & TIRES	40
LIGHTING	46
HUNT	48
POLARIS NORTHSTAR COOLERS	50
PARTS & GARAGE	54
MAINTENANCE	54
OIL & LUBRICANTS	56
HD PARTS	58
SERVICE PARTS	60
CLEANERS & TRAILERING	62
APPAREL	64
RACING COLLECTION	64
RIDING GEAR	66
HELMETS & GOGGLES	68
MEN'S APPAREL	70
WOMEN'S APPAREL	76
MERCHANDISE	78

MODEL YEAR 2022

TAKE YOUR SPORTSMAN
TO THE NEXT LEVEL

GO FURTHER

WITH YOUR SPORTSMAN AND
MAKE IT YOUR OWN WITH POLARIS
ENGINEERED ACCESSORIES



MOST POPULAR ADD-ONS

Racks	P. 26
Storage	P. 28
Windshields	P. 30
Wheels & Tires	P. 40



MOST POPULAR ADD-ONS

Racks	P. 26
Storage	P. 28
Wheels & Tires	P. 40
Lighting	P. 46

ULTIMATE TRAIL

DESIGNED

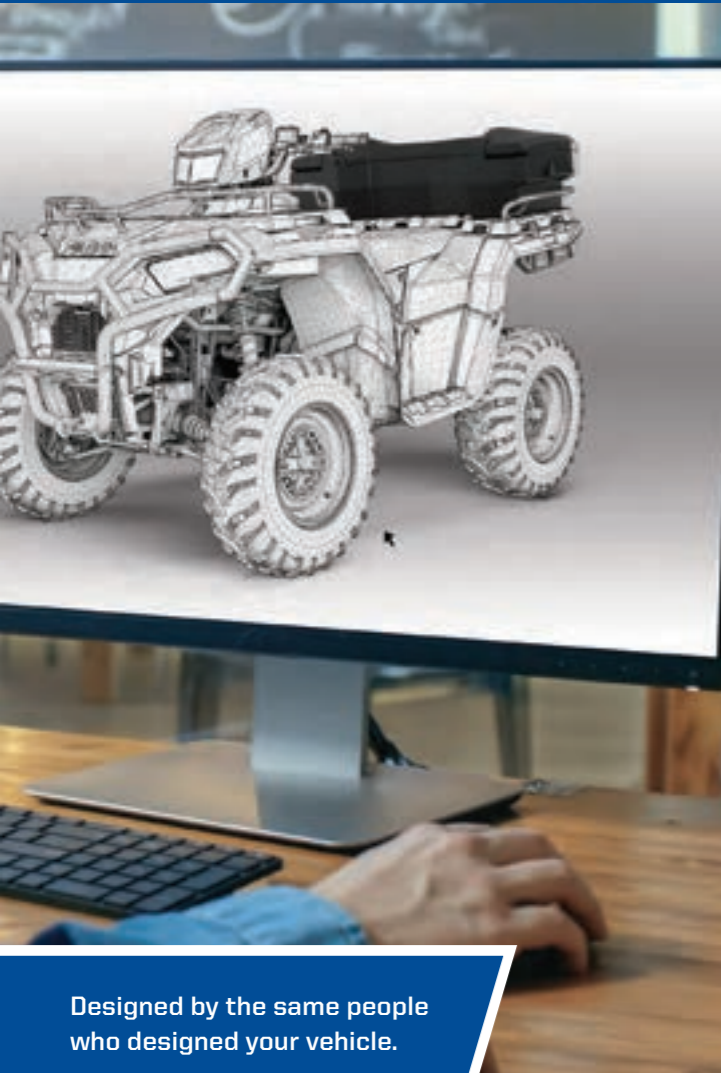

Designed by the same people who designed your vehicle.

TESTED



Extensively tested in the field so you ride with 100% confidence.

TRUSTED



65 years in the business. The #1 name in Off-Road.

WE HOLD OUR PARTNERS TO THE SAME STANDARDS



WHEELS, TIRES & LIGHTING DESIGNED WITH POLARIS TO MAXIMIZE PERFORMANCE
P. 40, 46



A GLOBAL LEADER IN AUDIO INNOVATION, DESIGN & ENGINEERING
P. 17, 29



PRODUCTS SO GOOD THEY REPLACE OR REPAIR THEM FOR LIFE
P. 46



MAKING PRODUCTS FOR AVID SPORTSMEN SINCE 1943
P. 48

ENGINEERED FOR MORE

Ensuring Polaris Engineered Accessories fit and work in sync with your machine is the most critical phase of testing and validation. With seamless integration, you can trust that any Polaris accessory you install will enhance your interaction beyond your expectations.



PRO PRO HEAVY DUTY SERIES

WINCHES

INTEGRATED WINCH MOUNT & PRE-WIRED

Designated mounting points and pre-wired contactors ensure a perfect fit and the strongest place to attach the Polaris Engineered winch - the most dependable winch for your SPORTSMAN. With wiring built right into the vehicle, we made this the easiest SPORTSMAN winch ever made to install.

P. 10

GLACIER PLOW SYSTEM

INTEGRATED PLOW MOUNT

The attachment points for the Glacier Plow System are integrated right at the factory and feature an innovative drive-up and go installation process.

P. 36

LOCK & RIDE®

CARGO VERSATILITY

Lock & Ride mounting locations allow for limitless customization to let you work the way you want.

P. 17, 28

SUPERIOR INTEGRATION

Right from the factory, your vehicle is built to make essential accessories like winches and plows easy to use day-in and day-out. Mounting brackets are designed into the oversized factory bumper and wiring is routed securely and properly. When it comes to SPORTSMAN, Polaris Engineered Accessories make work easier so you can get more done.



POLARIS ENGINEERED WINCHES

- ✓ Tested 1,200+ pulls at max load, it works when you need it to
- ✓ Built for winter, withstands $-29^{\circ}C$ temperatures
- ✓ **Pre-wired chassis**
Factory-installed wiring makes the controls simple to install. Mount the winch, connect the wires and trust that everything is routed safely, securely, and properly.
- ✓ **No need to cut panels**
- ✓ Sealed motor and heavy-duty gears operate fully submerged underwater
- ✓ Military tested and approved

TO LEARN MORE ABOUT POLARIS ENGINEERED WINCHES, SEE P. 10

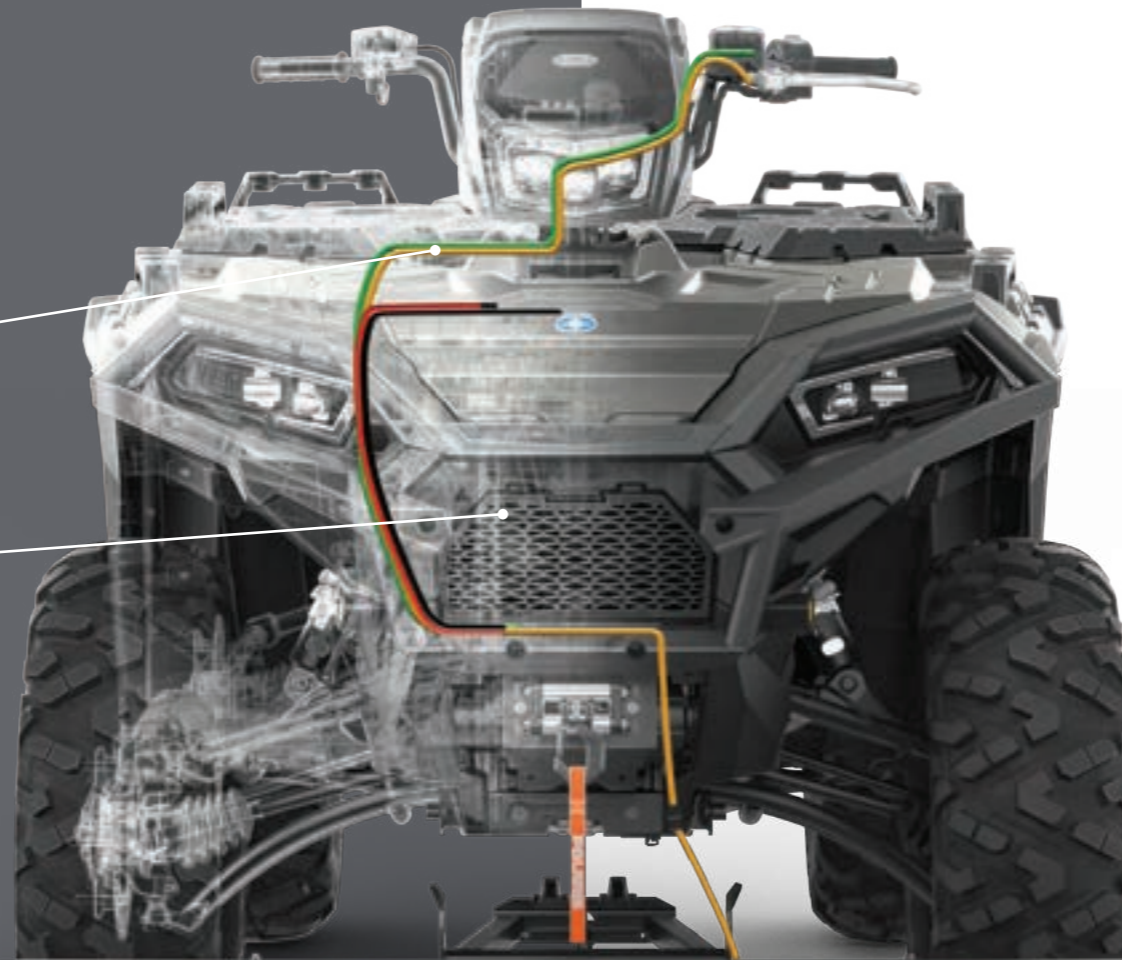

GLACIER PLOW SYSTEM

- ✓ Easily engage and disengage the plow system from your SPORTSMAN
- ✓ No loss of factory ground clearance when not plowing
- ✓ Don't have to crawl under the machine to release the plow blade from the vehicle
- ✓ No trimming of vehicle plastic required to mount plow or winch

TO LEARN MORE ABOUT THE GLACIER PLOW SYSTEM, SEE P. 36

WINCHES



ADD A PLOW
P. 36

PRO PRO HEAVY DUTY SERIES

TOP-OF-THE-LINE FEATURES

BEST FOR PLOWING, HEAVY-DUTY OUTDOOR CHORES & TRAIL RIDING

HD HEAVY DUTY SERIES

BUILT FOR THE OFF-ROAD

BEST FOR THE CASUAL OFF-ROAD RIDER



DEPENDABLE. TOUGH. BUILT FOR THE OFF-ROAD.

A Polaris Engineered winch is designed to help you get the job done right, get you on your way faster and prepare you for the unexpected.

WHY POLARIS?

Polaris off-road vehicles are engineered with designated mounting points and wiring for seamless install of Polaris Engineered winches.

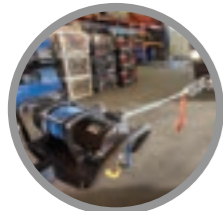

TESTED **1,200+**
PULLS AT MAX LOAD



BUILT TO WITHSTAND
-29° C TEMPERATURES



OPERATES FULLY
SUBMERGED



MILITARY
TESTED & APPROVED

REPLACEMENT PART



REPLACEMENT STEEL CABLE

- 1588 kg winch series - 15.2 m
- » 2878890



RECOVERY STRAP

- 5cm x 9.1 m (8165 kg)
- Comes with carry bag
- » 2884033

FEATURES & BENEFITS

ALL POLARIS ENGINEERED WINCHES COME WITH:

- ✓ INTEGRATED WIRING, MOUNT, PREASSEMBLED
- ✓ HOOK WITH STRAP
- ✓ CUT STEEL GEARS & SEALED DRIVETRAIN
- ✓ SEALED PERMANENT MAGNET MOTOR



Retrieve cable 5x as fast as standard mode on other Polaris winches. Get back to riding or complete your task quicker.

1. Set winch dial to N (Neutral) to manually pull the rope out and secure the hook to your anchor point
2. Set winch dial to L (Low) for maximum pulling power while winching your load
3. Set winch dial to H (High) for retrieving the rope 5x faster with Rapid Rope Recovery

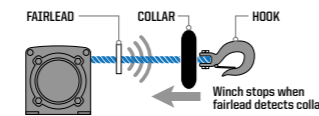

Auto Stop technology protects and extends the life of your winch by automatically stopping the winch at the end of pull to prevent over-spooling. While plowing, it prevents the plow frame from bending by stopping the winch once the plow has been lifted.



With its lightweight, yet extremely strong, design and superior flexibility, this 15.2 m long synthetic rope is easy to handle and can stand up to any tough job.



This convenient remote operates your Polaris winch wirelessly from within 15.2 m of the vehicle. Operate your winch safely outside your vehicle while on the job site or trails.

MODEL

450 H.O. '21-22
570 '21-22

450 H.O. '16-20
570 '14-20
X2 570 '15-21
TOURING 570 '14-21
6X6 570 '17-21

850 '12-22
XP 1000 '15-22
TOURING XP 1000 '15-22
TOURING 850 '15-22
SCRAMBLER 850 '14-22

SPORTSMAN XP 1000 S '20-22
SCRAMBLER XP 1000 S '20-21

PRO PRO HEAVY DUTY SERIES

HD HEAVY DUTY SERIES



NOT AVAILABLE



ADD AUTO STOP TECHNOLOGY



2881693
SYNTHETIC ROPE REQUIRED
FITS WINCHES: 2880434, 2880432



2889253
SYNTHETIC ROPE REQUIRED
FITS WINCHES: 2884832, 2884833, 2889469, 2889470



TOP SELLER
ADD SYNTHETIC ROPE
2878888



ADD WIRELESS WINCH REMOTE

2879316

1588 kg
with Synthetic Rope

TOP SELLER
2884834

1588 kg
with Synthetic Rope

TOP SELLER
2884833

TOP SELLER
2880434

NEW
2889470

1134 kg
with Steel Cable

TOP SELLER
2884832

TOP SELLER
2880432

NEW
2889469

2883580

COMFORT ESSENTIALS



Polaris Pro HD 1,588 kg Winch	P. 14	LED Light Kit	P. 16	Pro Armor Wheel & Tire Set: Dual Threat/4202	P. 45
Trail Brushguard	P. 14	Rear Power Harness	P. 16	Lug Nuts	P. 45
Rear Brushguard	P. 14	LOCK & RIDE Rear Audio Storage Box	P. 17	RIGID D-Series Pro Driving LED Light	P. 46
Rear Rack Extender	P. 15	Audio Storage Box Remote	P. 17	Lightbar Harness	P. 47
Handguards	P. 16	NEW Pod Bag	P. 17	LED Y-Harness	P. 47
Handguard Mount	P. 16	NEW Fender Bag	P. 17		

HUNTER



Polaris HD 1,588 kg Winch	P. 14	LOCK & RIDE Tall Windshield	P. 18	Lightbar Harness	P. 47
HD Front Brushguard with Hitch	P. 14	Pro Armor Wheel & Tire Set: Mud XC/4205	P. 45	Gun Boot L	P. 48
Rear Rack Extender	P. 15	Lug Nuts	P. 45	Stronghold Auto-Latch Mount	P. 48
Hand & Thumb Warmer Kit	P. 16	RIGID SR-Series 25.4 cm Combo LED Light	P. 47	LOCK & RIDE Rhino Grip Pro	P. 48

WORK HARD AND GET IT DONE with Polaris Engineered Accessories. Find everything you need to outfit your trusted partner for the task at hand.

WORKER



Polaris HD 1,134 kg Winch	P. 14	Rear Rack Extender	P. 15	LOCK & RIDE Open Cargo Box	P. 17
Rear Brushguard	P. 14	Front Utility Rack	P. 15	LOCK & RIDE Mid Windshield	P. 18
HD Front Brushguard with Hitch	P. 14	Rear Utility Rack	P. 15	Pro Armor Wheel & Tire Set: Harvester/4204	P. 45
Body Armor	P. 15	Rear Power Harness	P. 16	Lug Nuts	P. 45

WINTER



Polaris Pro HD 1,588 kg Winch	P. 14	LOCK & RIDE Rear Cargo Box	P. 17	Glacier Pro Plow Blade - 167.6 cm Poly	P. 37
HD Front Brushguard with Hitch	P. 14	LOCK & RIDE Tall Windshield	P. 18	RIGID SR-Series 25.4 cm Combo LED Light	P. 47
Rear Rack Extender	P. 15	Glacier Integrated Plow Mount	P. 37	Lightbar Harness	P. 47
Hand & Thumb Warmer Kit	P. 16	Glacier Pro Steel ATV Plow Frame	P. 37		

2022 SPORTSMAN 570



WINCHES

POLARIS PRO HD 1,588 kg WINCH TOP SELLER

- Adds 1,588 kg of pulling capacity with Auto Stop Technology for plowing applications
- Rapid Rope Recovery recovers open cable 5x as fast as standard mode on other Polaris winches

» 2884834
SPORTSMAN 450/570 '21-22



LEARN MORE ON P. 10

POLARIS HD 1,588 kg WINCH TOP SELLER

- Adds 1,588 kg of pulling capacity with quick and easy installation
- Includes all components required for installation plus 15m of .5 cm premium high-strength synthetic rope

» 2884833
SPORTSMAN 450/570 '21-22



POLARIS HD 1,134 kg WINCH TOP SELLER

- Adds 1,134 kg of pulling capacity with quick and easy installation
- Includes all components required for installation plus 15m of .5 cm high-strength steel cable

» 2884832
SPORTSMAN 450/570 '21-22



NEED A PLOW? SEE P. 36

PROTECTION



TRAIL BRUSHGUARD TOP SELLER

- Provides enhanced protection from brush and debris
- Has designated light bar holes and is compatible with winch and Body Armor

» 2884844
SPORTSMAN 450/570 '21-22



REAR BRUSHGUARD TOP SELLER

- Protect your vehicle from brush, sticks, rocks and light bumps into solid objects
- Made of sturdy 3.2 cm steel tube with a matte black finish

» 2884847
SPORTSMAN 450/570 '21-22



HD FRONT BRUSHGUARD WITH HITCH

- Adds heavy-duty protection with a custom look
- Has designated light bar holes and is compatible with winch and Body Armor
- Standard front receiver hitch for additional functionality

» 2884850
SPORTSMAN 450/570 '21-22

RACKS



BODY ARMOR

- Provides extra protection to your ATV's full body and fenders

» 2884851
SPORTSMAN 450/570 '21-22
Front bumper (2884850 or 2884844) required for installation

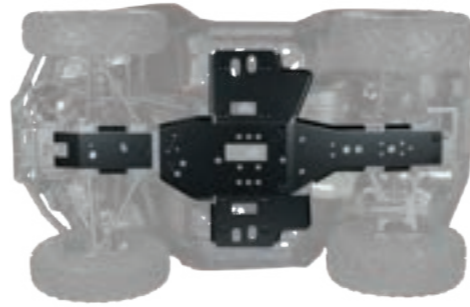

SKID PLATE

- Built to be tough from 10mm thick high-density polyethylene

» 2884852
SPORTSMAN 450/570 '21-22



REAR RACK EXTENDER TOP SELLER

- Forms a 7.6 cm tall perimeter around the rear cargo rack to keep gear secure which maximizes your cargo capabilities
- Durable steel construction provides a sturdy tie down anchor for loose gear
- Compatible with Cargo Boxes and Rear Utility Rack

» 2884841
SPORTSMAN 450/570 '21-22



FRONT UTILITY RACK TOP SELLER

- Tubular steel rack that attaches on top of front plastic rack providing protection and multiple tie down points

- 1.9 cm diameter matte black steel tube

» 2884842
SPORTSMAN 450/570 '21-22



REAR UTILITY RACK TOP SELLER

- Replaces rear plastic rack with a strong flat steel rack with integrated tie down points

- Works with all Lock & Ride accessories, rack extenders, and gun mounts

» 2884843
SPORTSMAN 450/570 '21-22

2022 SPORTSMAN 570



COMFORT



HANDGUARDS

- BRIGHT WHITE 2876883
- BLACK TOP SELLER 2876846
- INDY RED 2876845

- Handguard Mount (2889341) is required when installing Polaris Handguards
- Does not fit with windshields or Handlebar Mounted Mirrors

NEW
» 2889341 • MOUNT
SPORTSMAN 450/570 '21-22



HAND & THUMB WARMER KIT TOP SELLER

- Provides heat to grips and throttle and is easily installed by plugging into pod
 - Includes two heated grips and one throttle warmer
- » 2885002
SPORTSMAN 450/570 '21-22



HANDLEBAR MOUNTED MIRRORS TOP SELLER

- Enhances visibility of what's behind you for added safety
 - Sold as a pair
 - Does not fit with windshields or Handguards
- » 2877222
SPORTSMAN 450/570 '21-22



LED LIGHT KIT

- Upgrade your standard headlights and pod lights to LEDs with this upgrade kit
- » 2884859
SPORTSMAN 450/570 '21-22



REAR POWER HARNESS

- Provides power to the rear of the ATV for electrical accessories including Rear Audio Storage Box
- » 2889070
SPORTSMAN 450/570 '21-22

AUDIO



LOCK & RIDE REAR AUDIO STORAGE BOX

- Dual 15.2 cm speakers by Rockford Fosgate that connect via Bluetooth
 - Mounts easily with Lock & Ride to the rear rack and is compatible with rack extenders, utility rack, and gun mount
 - Rest easy knowing that your speakers are protected with a sealed-lid container
 - Rear Power Harness required for installation (2889070)
- » 2884856
SPORTSMAN 450/570 '21-22



AUDIO STORAGE BOX REMOTE

- Easily control the volume or switch to the next song on your Rear Audio Storage Box
 - Conveniently mounts to your ATV's handlebars
- » 2884987
SPORTSMAN 450/570 '21-22

STORAGE

NEW POD BAG

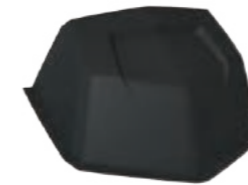

- Keep your essentials in reach with 2 Liters of storage capacity
 - Mounts to the top of the light pod with HD Velcro
 - Semi-rigid construction and PU Laminated EVA material keeps belongings protected from the elements
 - Compatible with windshields
- » 2889286
SPORTSMAN 450/570 '21-22

NEW FENDER BAG



- Provides easy-access 8.3 Liters of storage
 - Mounts to the front left fender with HD Velcro
 - Semi-rigid construction with PU Laminated EVA material keeps belongings protected from the elements
- » 2889287
SPORTSMAN 450/570 '21-22

NEW REAR RACK EXTENDER BAGS



- Three bags included (Rear Rack Extender sold separately)
 - Mounts to Rear Rack Extender with HD Velcro
 - Add a convenient 1 Liter of storage without sacrificing the rear rack
 - Made to withstand the elements and wear with durable ballistic nylon construction (1680 Nylon and 600D SPD)
 - Rear Rack Extender (2884841) is required
- » 2889411
SPORTSMAN 450/570 '21-22

NEW UNDERSEAT BAG



- Provides an extra 8.3 Liters of storage capacity
 - Mounts directly under your seat via a Velcro wrap
 - Durable semi-rigid construction keeps items protected
- » 2889454
SPORTSMAN 450/570 '21-22

LOCK & RIDE REAR CARGO BOX



- Increase your storage with an extra 80.4 liters of dry, dust-proof storage
 - Mounts easily with Lock & Ride to the rear rack and is compatible with rack extenders, utility rack, and gun mount
 - Includes 2 padlock locations
- » 2884853
SPORTSMAN 450/570 '21-22

LOCK & RIDE OPEN CARGO BOX



- Increase your storage with an extra 83.3 liters of convenient storage space
 - Mounts easily with Lock & Ride to the rear rack and is compatible with rack extenders, utility rack, and gun mount
 - Holds two 18.9-liter buckets with integrated grab handle to make it easy to carry and transport cargo
 - 12 convenient tie-down locations to secure cargo
- » 2884854
SPORTSMAN 450/570 '21-22

LOCK & RIDE REAR COOLER BOX



- Increase your storage with an extra 46 quarts of weather resistant cooler storage
 - Mounts easily with Lock & Ride to the rear rack and is compatible with rack extenders, utility rack, and gun mount
 - Integrated bottle opener and 2 padlock locations
- » 2884857
SPORTSMAN 450/570 '21-22

2022 SPORTSMAN 570



DO MORE

WINDSHIELDS



NEW
Tall 48.9 cm Clear

Tall 48.9 cm Clear

Mid 39.4 cm Clear

Short 24.1 cm Clear

LOCK & RIDE WINDSHIELDS

- Lock & Ride technology allows for easy installation and removal in seconds without tools
- Poly windshields are flexible, impact-resistant, and provide long-term value over the life of your machine
- Three heights available for whatever coverage you prefer
- Does not work with Handguards or Handlebar Mounted Mirrors

SIZE	COLOR	PART #
TALL 48.9 cm	CLEAR	2884945
MID 39.4 cm	CLEAR	2884845
SHORT 24.1 cm	CLEAR	2884946

SPORTSMAN 450/570 '21-22

NEW FALL AVAILABILITY

TALL 48.9 cm	CLEAR	2889491
--------------	-------	---------

SPORTSMAN 450/570 '22 WITH 7" DISPLAY INSTALLED



PLOWS P. 36



WHEELS & TIRES P. 40



LIGHTING P. 46



SPORTSMAN

2014-2021
570 X2

2014-2022
570 6X6

570 TOURING



WINCHES

POLARIS HD 1,588 kg WINCH TOP SELLER

» 2880434
X2 570 '15-21, TOURING 570 '14-22, 6X6 570 '17-22



POLARIS HD 1,134 kg WINCH TOP SELLER

» 2880432
X2 570 '15-21, TOURING 570 '14-22, 6X6 570 '17-22



STORAGE



SEMI-RIGID TOURING CARGO BAG

- Large-capacity, heavy-duty vinyl bag
- Three zippered openings, removable dividers
- Attaches to rack with Velcro straps

» 2877220
TOURING 570 '14-22

NEED A PLOW? SEE P. 36

COMFORT



HAND WARMERS TOP SELLER

» 2877363
X2 570 '15-21, TOURING 570 '14-22, 6X6 570 '17-22



THROTTLE/THUMB WARMER TOP SELLER

» 2877364
X2 570 '15-21, TOURING 570 '14-22, 6X6 570 '17-22

HANDGUARDS

- BRIGHT WHITE 2876883
- BLACK TOP SELLER 2876846
- INDY RED 2876845

- Handguard Mount (2889341) is required when installing Polaris Handguards
- Does not fit with windshields or Handlebar Mounted Mirrors

NEW
» 2889341 • MOUNT
X2 570 '15-21, TOURING 570 '14-22, 6X6 570 '17-22



HANDLEBAR MOUNTED MIRRORS TOP SELLER

- Enhances visibility of what's behind you for added safety
- Sold as a pair
- Does not fit with Windshield Fairing or Handguards

» 2877222
X2 570 '15-21, TOURING '570 14-22, 6X6 570 '17-22

PROTECTION, RACKS & WINDSHIELDS



FRONT BRUSHGUARD TOP SELLER

» 2879714
X2 570 '15-21, TOURING 570 '14-22, 6X6 570 '17-22



REAR BRUSHGUARD

» 2879715
TOURING 570 '14-22



ULTIMATE SERIES FRONT RACK EXTENDER 10.2 CM

» 2879716
X2 570 '15-21, TOURING 570 '14-22, 6X6 570 '17-22



LOCK & RIDE YUKON ADVENTURE RACK

- Adds increased storage volume by allowing you to increase storage height securely

» 2882084
6X6 570 '17-22

LOCK & RIDE WINDSHIELDS

- Lock & Ride technology allows for easy installation and removal in seconds without tools
- Poly windshields are flexible, impact-resistant, and provide long-term value over the life of your machine
- Does not work with Handguards

SIZE	COLOR	PART #
TALL 48.9 cm	CLEAR	2880539-409
MID 39.4 cm	SMOKE	2880540-412

X2 570 '18-21, TOURING 570 '18-22



Tall 48.9 cm Clear



Mid 39.4 cm Smoke

2014-2020 SPORTSMAN 570

WINCHES

POLARIS HD 1,588 kg WINCH TOP SELLER

» 2880434
450/570 '14-20



POLARIS HD 1,134 kg WINCH TOP SELLER

» 2880432
450/570 '14-20



NEED A PLOW? SEE P. 36

PROTECTION



FRONT BRUSHGUARD TOP SELLER

» 2879714
450/570 '14-20



REAR BRUSHGUARD

» 2879715
450/570 '14-20

RACKS



ULTIMATE SERIES FRONT RACK EXTENDER 10.2 CM

» 2879716
450/570 '14-20



ULTIMATE SERIES REAR RACK EXTENDER 10.2 CM

» 2879717
450/570 '14-20

STORAGE

LOCK & RIDE REAR CARGO BOX

- Increase your storage with an extra of capacity
- Store two full-size helmets
- Works with Rack Extenders
- Will not fit when Utility Rack is installed

» 2882882
450/570 '14-20



COMFORT



HAND WARMERS TOP SELLER

» 2877363
450/570 '14-20



THROTTLE/THUMB WARMER TOP SELLER

» 2877364
450/570 '14-20



HANDGUARDS

<input type="checkbox"/> BRIGHT WHITE	2876883
<input checked="" type="checkbox"/> BLACK <small>TOP SELLER</small>	2876846
<input type="checkbox"/> INDY RED	2876845

- Handguard Mount (2889341) is required when installing Polaris Handguards
- Does not fit with windshields or Handlebar Mounted Mirrors

NEW
» 2889341 • MOUNT
450/570 '14-20



HANDLEBAR MOUNTED MIRRORS TOP SELLER

- Enhances visibility of what's behind you for added safety
- Sold as a pair
- Does not fit with windshields or Handguards

» 2877222
450/570 '14-20

WINDSHIELDS

LOCK & RIDE WINDSHIELDS

- Lock & Ride technology allows for easy installation and removal in seconds without tools
- Poly windshields are flexible, impact-resistant, and provide long-term value over the life of your machine
- Does not fit with Handguards or Handlebar Mounted Mirrors

SIZE	COLOR	PART #
TALL 48.9 cm	CLEAR	2880539-409
MID 39.4 cm	SMOKE	2880540-412

450/570 '14-20



Tall 48.9 cm Clear



Mid 39.4 cm Smoke

COMFORT ESSENTIALS



NEW Polaris Pro HD 1,588 kg Winch	P. 26	LOCK & RIDE Rear Audio Storage Box	P. 29	Pro Armor Wheel & Tire Set: Dual Threat/4202	P. 45
Ultimate Series Rear Rack Extender	P. 26	Audio Storage Box Remote	P. 29	Lug Nuts	P. 45
Ultimate Series Front Brushguard	P. 27	Handguards	P. 29	RIGID D-Series Pro Driving LED Light	P. 46
Ultimate Series Rear Brushguard	P. 27	Handguard Mount	P. 29	Lightbar Harness	P. 47
NEW Pod Bag	P. 28	Rear Power Harness	P. 29	LED Y-Harness	P. 47

HUNTER



NEW Polaris HD 1,588 kg Winch	P. 26	LOCK & RIDE Tall Windshield	P. 30	Lightbar Harness	P. 47
Ultimate Series Rear Rack Extender	P. 26	Pro Armor Wheel & Tire Set: Mud XC/4205	P. 45	Gun Boot L	P. 48
Ultimate Series Front Brushguard	P. 27	Lug Nuts	P. 45	Stronghold Auto-Latch Mount	P. 48
Hand & Thumb Warmer Kit	P. 29	RIGID SR-Series 25.4 cm Combo LED Light	P. 47	LOCK & RIDE Rhino Grip Pro	P. 48

WORK HARD AND GET IT DONE with Polaris Engineered Accessories. Find everything you need to outfit your trusted partner for the task at hand.

WORKER



NEW Polaris HD 1,134 kg Winch	P. 26	Ultimate Series Rear Brushguard	P. 27	LOCK & RIDE Mid Windshield	P. 30
Ultimate Series Rear Rack Extender	P. 26	Ultimate Series Body Armor	P. 27	Pro Armor Wheel & Tire Set: Harvester/4204	P. 45
Ultimate Series Front Steel Rack	P. 27	LOCK & RIDE Open Cargo Box	P. 28	Lug Nuts	P. 45
Ultimate Series Front Brushguard	P. 27	Rear Power Harness	P. 29		

WINTER



NEW Polaris Pro HD 1,588 kg Winch	P. 26	Hand & Thumb Warmer Kit	P. 29	Glacier Pro Plow Blade - 167.6 cm Poly	P. 37
Ultimate Series Rear Rack Extender	P. 26	LOCK & RIDE Tall Windshield	P. 30	RIGID SR-Series 25.4 cm Combo LED Light	P. 47
Ultimate Series Front Brushguard	P. 27	Glacier Integrated Plow Mount	P. 37	Lightbar Harness	P. 47
LOCK & RIDE Rear Cargo Box	P. 28	Glacier Pro Steel ATV Plow Frame	P. 37		

SPORTSMAN XP 1000 XP 1000 S



WINCHES

POLARIS PRO HD 1,588 kg WINCH

» 2889580

SPORTSMAN XP 1000 S '20-22



NEW

» 2889471

SPORTSMAN 850 '12-22, SPORTSMAN XP 1000 '15-22,
SPORTSMAN TOURING XP 1000 '15-22,
SPORTSMAN TOURING 850 '15-22



RAPID ROPE RECOVERY

5X
FASTER

LEARN MORE ON P. 10

NEW POLARIS HD 1,588 kg WINCH

» 2889470

SPORTSMAN 850 '12-22, SPORTSMAN XP 1000 '15-22,
SPORTSMAN TOURING XP 1000 '15-22,
SPORTSMAN TOURING 850 '15-22



NEW POLARIS HD 1,134 kg WINCH

» 2889469

SPORTSMAN 850 '12-22, SPORTSMAN XP 1000 '15-22,
SPORTSMAN TOURING XP 1000 '15-22,
SPORTSMAN TOURING 850 '15-22



NEED A PLOW? SEE P. 36

RACKS

ULTIMATE SERIES RACK EXTENDER 10.2 cm

FRONT

» 2882022

SPORTSMAN XP 1000 S '20-22,
SPORTSMAN 850/1000 '17-22



REAR

» 2882023

SPORTSMAN XP 1000 S '20-22,
SPORTSMAN 850/1000 '17-22
Fits with Rear Cargo Box (2882882)



ULTIMATE SERIES RACK EXTENDER 17.8 CM

FRONT

» 2882024

SPORTSMAN XP 1000 S '20-22,
SPORTSMAN 850/1000 '17-22

Not shown



REAR

» 2882025

SPORTSMAN XP 1000 S '20-22,
SPORTSMAN 850/1000 '17-22

Does not fit with Rear Cargo Box (2882882)



FRONT RACK EXTENDER

» 2879890

SPORTSMAN 850/1000 TOURING '10-22
Does not fit with Front Cargo Box (2877951)

ULTIMATE SERIES STEEL RACK

FRONT

» 2883257

SPORTSMAN XP 1000 S '20-22,
SPORTSMAN 850/1000 '17-22



FRONT

REAR

» 2883258

SPORTSMAN XP 1000 S '20-22,
SPORTSMAN 850/1000 '17-22



REAR

ULTIMATE SERIES MOVEABLE TIE-DOWN POINTS

» 2882270
(FRONT & REAR - SOLD IN PAIRS)

SPORTSMAN 850/1000 '17-22



PROTECTION



ULTIMATE SERIES BRUSHGUARD

- Quick installation to the integrated mounting tubes on the vehicle using wedge-style expansion anchor mounts
- Attach the Body Armor to the Front Brushguard to provide the ultimate protection for the front fenders

» 2882020 • FRONT **TOP SELLER**

SPORTSMAN XP 1000 S '20-22,
SPORTSMAN 850/1000 '17-22

» 2882583 • REAR **TOP SELLER**

SPORTSMAN XP 1000 S '20-22,
SPORTSMAN 850/1000 '17-22

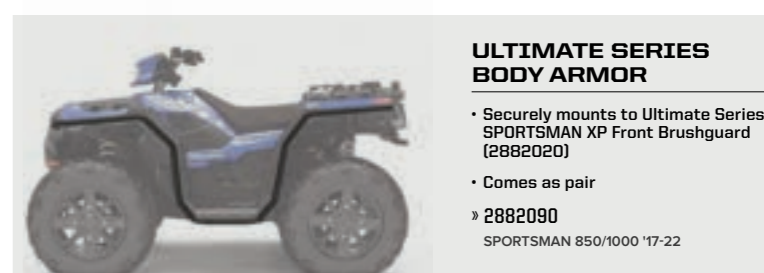

ULTIMATE SERIES BODY ARMOR

- Securely mounts to Ultimate Series SPORTSMAN XP Front Brushguard (2882020)
- Comes as pair

» 2882090

SPORTSMAN 850/1000 '17-22



TOURING XP BRUSHGUARD

- Adds heavy-duty protection and a custom look

» 2878709 • FRONT

SPORTSMAN 850/1000 TOURING '10-22

» 2878324 • REAR

SPORTSMAN 850/1000 TOURING '10-22

SPORTSMAN XP 1000 XP 1000 S



STORAGE



LOCK & RIDE REAR CARGO BOX

- Increase your storage with an extra 80.4 liters of dry, dust-proof storage
 - Mounts easily with Lock & Ride to the rear rack and is compatible with rack extenders and gun mount
 - Includes 2 padlock locations
 - Will not fit when Ultimate Series Steel Rack is installed
- » 2884853
SPORTSMAN XP 1000 S '20-22, SPORTSMAN 850/1000 '17-22



LOCK & RIDE OPEN CARGO BOX

- Increase your storage with an extra 83.3 liters of convenient storage space
 - Mounts easily with Lock & Ride to the rear rack and is compatible with rack extenders and gun mount
 - Holds 2, 18.9-liter buckets with integrated grab handle to make it easy to carry and transport cargo
 - 12 convenient tie-down locations to secure cargo
 - Includes 2 padlock locations
 - Will not fit when Ultimate Series Steel Rack is installed
- » 2884854
SPORTSMAN XP 1000 S '20-22, SPORTSMAN 850/1000 '17-22



LOCK & RIDE REAR COOLER BOX

- Increase your storage with an extra 46 quarts of weather-resistant cooler storage space
 - Mounts easily with Lock & Ride to the rear rack and is compatible with rack extenders and gun mount
 - Integrated bottle opener and 2 padlock locations
 - Will not fit with Ultimate Series Steel Rack
- » 2884857
SPORTSMAN XP 1000 S '20-22, SPORTSMAN 850/1000 '17-22

NEW POD BAG

- Keep your essentials in reach with 2 Liters of storage capacity
 - Mounts to the top of the light pod with HD Velcro
 - Semi-rigid construction and PU Laminated EVA material keeps belongings protected from the elements
 - Compatible with windshields
- » 2889286
SPORTSMAN 850/1000 21-22



ULTIMATE SERIES READY PACK

- Keep your trail essentials at the ready with this easy-to-access, weather-resistant storage compartment
- » 2882271
SPORTSMAN 850/1000 '17-22



LOCK & RIDE FRONT CARGO BOX

- » 2877951
SPORTSMAN 850/1000 TOURING '10-22
Front Rack Extender cannot be installed at the same time as the Front Cargo Box



LOCK & RIDE REAR STORAGE BOX

- » 2878000
SPORTSMAN 850/1000 TOURING '10-22
Slight interference with SPORTSMAN Touring 550/850 '11-14 passenger handles

AUDIO



LOCK & RIDE REAR AUDIO STORAGE BOX

- Dual 15.2 cm speakers by Rockford Fosgate that connect via Bluetooth
 - Mounts easily with Lock & Ride to the rear rack and is compatible with rack extenders and gun mount
 - Rest easy knowing that your speakers are protected with a sealed-lid container
 - Rear Power Harness (2889071) is required
- » 2884856
SPORTSMAN XP 1000 S '20-22, SPORTSMAN 850/1000 '17-22



AUDIO STORAGE BOX REMOTE

- Easily control the volume or switch to the next song on your Rear Audio Storage Box
 - Conveniently mounts to your ATV's handlebars
- » 2884987
SPORTSMAN XP 1000 S '20-22, SPORTSMAN 850/1000 '17-22

COMFORT



HANDLEBAR MOUNTED MIRRORS TOP SELLER

- Enhances visibility of what's behind you for added safety
 - Sold as a pair
 - Does not fit with Windshield Fairing or Handguards
- » 2877222
SPORTSMAN XP 1000 S '20-22, SPORTSMAN 850/1000 TOURING '10-22, SPORTSMAN 850/1000 '09-22,



HAND & THUMB WARMER KIT TOP SELLER

- Provides heat to grips and throttle and is easily installed by plugging into pod
 - Includes two heated grips and one throttle warmer
- » 2885002
SPORTSMAN XP 1000 '20-22



HAND WARMERS TOP SELLER

- » 2877363
SPORTSMAN XP 1000 S '20, SPORTSMAN XP 1000 '15-20, SPORTSMAN 850 '15-20, SPORTSMAN TOURING XP 1000 '15-22, SPORTSMAN TOURING 850 '15-22



THROTTLE/THUMB WARMERS TOP SELLER

- » 2877364
SPORTSMAN XP 1000 S '20, SPORTSMAN XP 1000 '15-20, SPORTSMAN 850 '15-20, SPORTSMAN TOURING XP 1000 '15-22, SPORTSMAN TOURING 850 '15-22



HANDGUARDS

<input type="checkbox"/> BRIGHT WHITE	2876883
<input checked="" type="checkbox"/> BLACK <small>TOP SELLER</small>	2876846
<input checked="" type="checkbox"/> INDY RED	2876845

- Handguard Mount (2889341) is required when installing Polaris Handguards
- Does not fit with windshield or Handlebar Mounted Mirrors

NEW » 2889341 • MOUNT

- SPORTSMAN XP 1000 S '20-22, SPORTSMAN 850/1000 TOURING '10-22, SPORTSMAN 850/1000 '09-22,



NEW REAR POWER HARNESS

- Provides power to the rear of the ATV for electrical accessories including Rear Audio Storage Box
- » 2889071
SPORTSMAN XP 1000 S '20-22, SPORTSMAN XP 1000 '17-22, SPORTSMAN 850 '17-22

SPORTSMAN XP 1000 XP 1000 S



DO MORE

WINDSHIELDS

LOCK & RIDE WINDSHIELDS

- Provides enhanced protection from the elements and off-road hazards
- Easily installs and removes without tools utilizing Lock & Ride technology
- Improved mounting system for easier and quicker attachment and detachment

SIZE	COLOR	PART #
TALL 48.9 cm	CLEAR	2884945
MID 39.4 cm	CLEAR	2884845
SHORT 24.1 cm	CLEAR	2884946

SPORTSMAN XP 1000 S '21-22, SPORTSMAN XP 1000 '21-22, SPORTSMAN 850 '21-22



LOCK & RIDE WINDSHIELDS

- Installs and removes in seconds without tools with Lock & Ride technology
- Poly windshields are flexible, impact-resistant, and provide long-term value over the life of your machine
- Does not work with Handguards

SIZE	COLOR	PART #
TALL 48.9 cm	CLEAR	2880539-409
MID 39.4 cm	SMOKE	2880540-412

SPORTSMAN TOURING XP 1000 '15-22, SPORTSMAN TOURING 850 '15-22



LOCK & RIDE ULTIMATE SERIES WINDSHIELD FAIRING

- Customizable system based on your style and protection needs
- Install the fairing to add one of the Ultimate Series Windshields below
- Does not work with Handguards or Handlebar Mounted Mirrors

» 2882512

SPORTSMAN XP 1000 S '20, SPORTSMAN XP 1000 '17-20, SPORTSMAN 850 '17-20



ULTIMATE SERIES WINDSHIELDS

- Fairing required to add your preferred windshield

SIZE	PART #
TALL 50.8 CM	2882152
MID 40.6 CM	2882151

SPORTSMAN XP 1000 S '20, SPORTSMAN XP 1000 '17-20, SPORTSMAN 850 '17-20



EASY TO CHANGE WINDSHIELDS WITH 6-DART INSTALL

Our fairing system allows for changing out the windshield quickly and easily. Simply remove the six dart-type fasteners and swap out the windshield.

PLOWS

P. 36



WHEELS & TIRES

P. 40



LIGHTING

P. 46

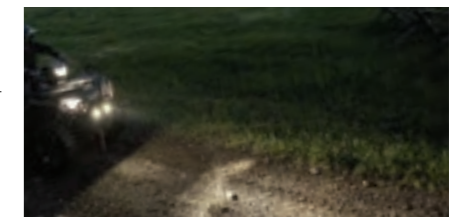

HUNT

P. 48



SCRAMBLER XP 1000 S



MISCELLANEOUS ACCESSORIES



WINCHES

POLARIS PRO HD 1,588 kg WINCH

» 2883580
SCRAMBLER XP 1000 S '20-21



NEW

» 2889471
SCRAMBLER 850 '14-22,
SCRAMBLER XP 1000 '14-18



NEW

POLARIS HD 1,588 kg WINCH

» 2889470
SCRAMBLER 850 '14-22, SCRAMBLER XP 1000 '14-18



NEW

POLARIS HD 1,134 kg WINCH

» 2889469
SCRAMBLER 850 '14-22, SCRAMBLER XP 1000 '14-18



RACKS/STORAGE



LARGE REAR RACK

» 2879139
SCRAMBLER XP 1000 S '20-21, SCRAMBLER XP 1000 '14-18,
SCRAMBLER 850 '14-22
Not compatible with Ogio Bag (2879925)



OGIO BAG

» 2879925
SCRAMBLER XP 1000 S '20-21, SCRAMBLER XP 1000 '14-18,
SCRAMBLER 850 '14-22

PROTECTION



ULTIMATE SPORT SERIES FRONT BRUSHGUARD

» 2883595
SCRAMBLER XP 1000 S '20-21



FRONT BRUSHGUARD

» 2879136
SCRAMBLER 850 '14-22, SCRAMBLER XP 1000 '14-18
Replaces existing lower bumper – will not work together



BOOM SPRAYER

» 2882266
ALL SPORTSMAN MODELS EXCEPT TOURING



ATV LICENSE PLATE

• Includes numbers and letters
» 2873270



QUICKTAP BATTERY POSTS

• Easy-to-access terminal posts give you quick access to the battery power
• Ideal for charging your battery, powering a temporary accessory, or when you need to offer an unexpected jump-start
• Connection posts feature covers to protect terminals when not in use
» 2882110



RIDE & REPAIR ESSENTIALS KIT

• 12-volt DC portable air compressor
• Tire repair kit with 6 plugs
• Basic first-aid kit with bandages, scissors, safety pins, and more
• 12-volt jumper cables
• Duct tape - 300mm x 1 roll
• Zip ties - 150mm length
• Electrical tape
• Ratchet strap - 50mm
• Microfiber cloth
• Carry bag

» 2881207

YOUTH ATV OUTLAW 70 EFI

THE PERFECT FIRST ALL-TERRAIN VEHICLE FOR
KIDS STARTING AT 6 YEARS AND OLDER.



FRONT BRUSHGUARD

- Provides enhanced protection from brush and other debris on the trail

» 2884567

OUTLAW 70 EFI '21-22



REAR BRUSHGUARD

- Protect the rear of your youth ATV from hazards on the trails

» 2884778

OUTLAW 70 EFI '21-22



WINDSHIELD - POLY

- Added wind and hand protection with a durable poly design

» 2885005

OUTLAW 70 EFI '21-22



DECAL KIT - INDY RED

- Replaces the stock Outlaw 70 decals to provide a unique and custom look for your youth ATV

» 2885107

OUTLAW 70 EFI '21-22

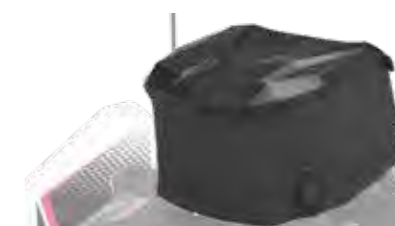

REAR STORAGE BAG

- Convenient storage that easily connects to the rear rack

» 2884555

OUTLAW 70 EFI '21-22

Images taken on private land. The use of vehicles by youth in similar environments in your jurisdiction may be prohibited per locally applicable laws and regulations. Keep your children safe and make sure an adult exercises close supervision at all times.

GLACIER[®] PLOW SYSTEM

TAKE COMMAND OF
CLEARING SNOW AND
MAKE QUICK WORK OF
EVEN THE HEAVIEST JOBS.



THE POLARIS ENGINEERED ADVANTAGE

INSTALLATION

30 seconds: Drive up, clip in, lock down, and go – the integrated Polaris Engineered Glacier Plow System simplifies plowing.



CONVENIENCE

Lift and angle adjustments can be made from the driver's seat.

ANGLE YOUR BLADE
RIGHT FROM YOUR SEAT
WITH THE GLACIERPRO
PLOW HYDRAULIC
ANGLE SYSTEM



ROBUST FRAME

A plow system is only as strong as its frame, and Polaris Engineered plow frames have a wide frame to withstand the rigors of heavy plowing.



DURABLE BLADES

Available in strong stamped steel or corrosion-resistant poly materials, Polaris Engineered plow blades cover a large surface area for quick snow removal.



168 cm POLY BLADE

152 cm & 132 cm STEEL BLADE

PLOW SYSTEMS (Winch required, sold separately)

Choose a Glacier Plow System, designed to help you get the most out of your SPORTSMAN during snowy months. Select a system based on your plowing needs with premium add-ons including a hydraulic lift system or additional plow accessories.

NEW! GLACIER PRO HD PLOW SYSTEM WITH HYDRAULICS

- System includes:
- Mount (2881424)
 - Frame (2879630)
 - 167.64 cm Poly Plow (2880269)
 - Hydraulic Angle (2879635)
 - Hydraulic Controller (2880836)
 - Plow Markers (2872726)
 - Plow Deflector (2879866)

» 3880010

450 '15-22, 570 '15-22, 6X6 570 '17-22,
X2 570 '15-21, 570 TOURING '15-22
REQUIRES LIFT METHOD: SEE WINCHES BELOW

NEW! GLACIER PRO HD PLOW SYSTEM

- System includes:
- Mount (2881424)
 - Frame (2879630)
 - 152.4 cm Steel Plow (2879638)

» 3880011

450 '15-22, 570 '15-22,
6X6 570 '17-22, X2 570 '15-21,
570 TOURING '15-22
REQUIRES LIFT METHOD:
SEE WINCHES BELOW

NEW! GLACIER PRO HD PLOW SYSTEM WITH HYDRAULICS

- System includes:
- Mount (2881423)
 - Frame (2879630)
 - 167.64 cm Poly Plow (2880269)
 - Hydraulic Angle (2879635)
 - Hydraulic Controller (2880836)
 - Plow Markers (2872726)
 - Plow Deflector (2879866)

» 3880012

XP 1000 '15-22, 850 '15-22, TOURING 1000 '15-22,
TOURING 850 '15-22, SCRAMBLER 850 '15-22
REQUIRES LIFT METHOD: SEE WINCHES BELOW

NEW! GLACIER PRO HD PLOW SYSTEM

- System includes:
- Mount (2881423)
 - Frame (2879630)
 - 152.4 cm Steel Plow (2879638)

» 3880013

XP 1000 '15-22, 850 '15-22,
TOURING 1000 '15-22,
TOURING 850 '15-22,
SCRAMBLER 850 '15-22
REQUIRES LIFT METHOD:
SEE WINCHES BELOW

ADD HYDRAULICS
Change the angle of the plow blade with the Power Controller.

25° LEFT AND RIGHT

HYDRAULIC CONTROL FOR EXTREME SNOW REMOVAL

NEED TRACKS? SEE P. 38

GLACIER PRO HD GIVES YOU:

» 66", 60" or 52" Blades

» Choice of poly or steel

» Ability to add a hydraulic angle system

MODELS	MANDATORY STEPS			OPTIONAL
	STEP 1 SELECT A MOUNT	STEP 2 SELECT A FRAME	STEP 3 SELECT PLOW CONFIGURATION	STEP 4 ADD HYDRAULICS
XP 1000 '15-22 850 '15-22 850/XP 1000 HIGHLIFTER '16-22 TOURING XP 1000 '15-22 TOURING 850 '10-22 SCRAMBLER 850 '14-22	2881423	2879630	Polaris Pro HD 1,588 kg Winch 2889471 Polaris HD 1,588 kg Winch 2889470 Polaris HD 1,134 kg Winch 2889469	168 cm Poly 2880269 152 cm Steel 2879638 132 cm Steel 2879639 Hydraulic Plow Blade Angle System 2879635 Power Controller 2880836 Power Controller Recommended
XP 1000 S '20-22 SCRAMBLER XP 1000 S '20-21	2883581		Polaris Pro HD 1,588 kg Winch 2883580	
570 '15-20 6X6 570 '17-22 X2 570 '15-21 TOURING 570 '14-22 450 H.O. '12-20	2881424		Polaris HD 1,588 kg Winch 2880434 Polaris HD 1,134 kg Winch 2880432	
570 '21-22 450 H.O. '21-22	2881424		Polaris Pro HD 1,588 kg Winch 2884834 Polaris HD 1,588 kg Winch 2884833 Polaris HD 1,588 kg Winch 2884832	

STEP 5 SELECT ACCESSORIES AND REPLACEMENT ITEMS

168 cm HD Wear Bar 2879868
168 cm Wear Bar 2879867
152 cm Wear Bar 2877243
132 cm Wear Bar 2877210

168 cm Plow Blade Snow Deflector 2879866
Plow Blade Deflector 2871808
Skid Shoe 2205071
Glacier Pro Shear Pin Replacement 2205063

Plow Winch Rope For 1,134 kg & 1,588 kg winches | 2878483
Glacier Plow Marker Sold in pairs | 2872726
Rear Tire Chains Recommended for rear tires only | 2881422
Plow Blade Track Extension Required for track equipped vehicles | 2879719

CHOOSE A PLOW SYSTEM

BUILD A PLOW SYSTEM

COMMON
WINCHES
570
XP 1000 - XP 1000 S
SCRAMBLER XP 1000 S
MISC & YOUTH
PLOW & TRACKS
WHEELS & TIRES
LIGHTING
HUNT & COOLERS

ALL-TERRAIN TRACTION

It's tough to make SPORTSMAN even more versatile than it already is. But with a set of Prospector Pro Tracks, you'll do just that. Tread through deep snow without concern.

Polaris-specific gearing provides 1:1 ratio to:

- Minimize track slip, providing better climbing ability and improved traction in deep snow
- Improve top speed over prior models by approximately 5%
- Reduce operating RPM for a quieter ride
- Improve driveline durability, which allows vehicle to run at a lower RPM, decreasing engine wear

Polaris exclusive optimized hub geometry that minimizes feedback and eases steering effort

Lightweight design provides for better flotation, eases steering effort, and provides better vehicle control

Flexible lug design provides the highest level of deep snow performance by lifting up in deep snow as opposed to digging down

New front dual stabilizer for improved stability

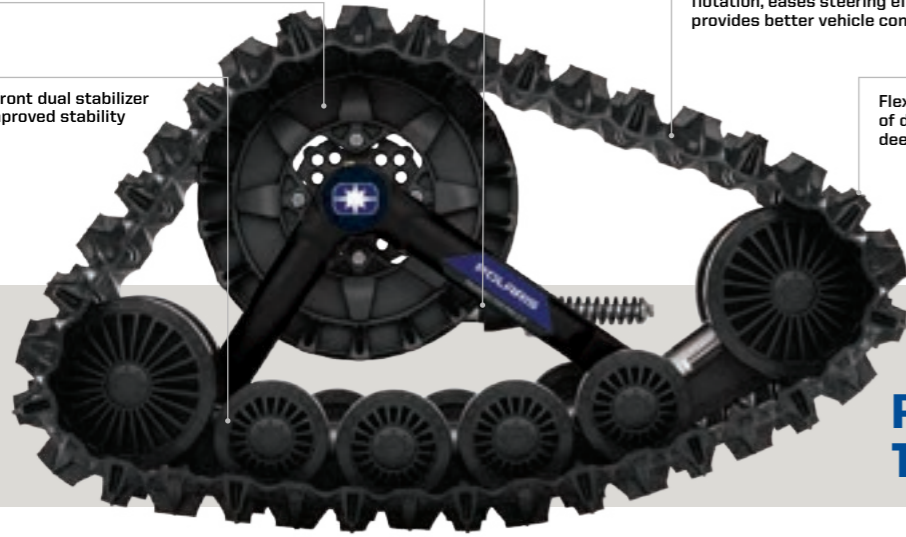

PROSPECTOR PRO 2.0 TRACK SYSTEM

STEP 1: SELECT A MOUNT KIT		
MODELS	A-ARMS	MOUNT KIT
SPORTSMAN XP 1000/850 (15-22) SPORTSMAN TOURING XP 1000/850 (15-22)	STRAIGHT	2879457
SPORTSMAN XP 1000/850 (16-22) HIGHLIFTER 1000/850 (16-22)	ARCHED	2882109
SPORTSMAN XP 1000 S (20-22) SCRAMBLER XP 1000 S (20-21)	ARCHED	2883977
SPORTSMAN 570 (21-22)	ARCHED	2889218
SPORTSMAN 570 (21-22)	STRAIGHT	2889219
SPORTSMAN 570 (15-22) SPORTSMAN TOURING 570 (15-22) SPORTSMAN X2 570 (15-21)	STRAIGHT	2879497

STEP 2: SELECT A TRACK KIT		
MODELS	EPS	TRACK KIT
SPORTSMAN 570 (15-22) SPORTSMAN TOURING 570 (15-22) SPORTSMAN X2 570 (15-21)	YES	2889493
SPORTSMAN XP 1000/850 (15-22) SPORTSMAN TOURING XP 1000/850 (17-22) HIGHLIFTER 1000 (16-22) SPORTSMAN XP 1000 S (20-22) SCRAMBLER XP 1000 S (20-21)	YES	2889495
SPORTSMAN 570 (14-22) SPORTSMAN TOURING 570 (15-22)	NO	2889492
SPORTSMAN XP 1000 (18-22) SPORTSMAN 850 (15-22) SCRAMBLER 850 (13-22)	NO	2889494

TRACK AND MOUNT KIT		
MODELS	EPS	TRACK AND MOUNT KIT
SPORTSMAN 570 6X6 (17-22)	YES	2882169

WANT TO PLOW?

GLACIER PRO PLOW TRACK EXTENSION









- Plow extension for use when using the Prospector Pro Track System and GlacierPro SPORTSMAN plow system

» 2879719

FOR USE WITH GLACIER PRO PLOW SYSTEMS

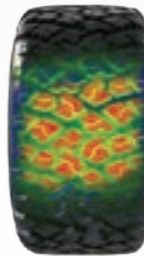

SPORTSMAN SNOW TRACTION OPTIONS

TREAD THROUGH SNOW WITH THESE OPTIONS	CONTACT PATCH	TURNING RADIUS
 <p>STOCK TIRES</p>	<p>GOOD</p> 	<p>354.3 cm</p> 
 <p>PRO ARMOR WHITEOUT</p>	<p>BETTER</p>  <p>MORE SURFACE AREA FOR BETTER FLOTATION ON SNOW</p>	<p>352.743 cm</p> 
 <p>NEW PROSPECTOR PRO 2.0 TRACKS</p>	<p>BEST</p>  <p>LESS AGGRESSIVE TREAD DISPLACES SNOW FOR BETTER HANDLING</p>	<p>445.453 cm</p> 

KNOW YOUR TERRAIN



- Tread patterns optimized for extreme traction
- Ideal for both hard pack and loose trail



- Flexible "grippy" tread
- Aggressive side bite



- Provides traction and durability
- Built to perform in hard sand, jagged rocks or any other extreme terrain



- Extra deep treads
- Self-cleaning lugs



- Paddles provide traction and durability in soft sand
- Built to float on top of sand



- Triple-belted sidewalls to resist puncture
- Purpose-built, long lasting tread patterns



- Handles extreme cold
- Holds shape and provides traction

SUPERIOR PERFORMANCE & DURABILITY

WAYS TO SHOP WHEELS & TIRES



LIFELONG PERFORMANCE

- Every tire is designed and constructed with longevity in mind
- 3,000+ mile rated (4,828 kilometers)

PREMIUM PROTECTION

- Pro Armor makes tires with extra protection exactly where it's needed most – the sidewall
- Triple-belted sidewalls keep your tires more resistant so you can keep going

TOUGH TIRES

- Higher ply ratings mean added protection
- Pro Armor builds 8 or 10-ply rated tires for higher puncture-resistance



KNOW YOUR TIRES

DIMENSIONS			TREAD DEPTH	TIRE WEIGHT	PLY RATING	SIDEWALL BELTS	LOAD RATING
TIRE HEIGHT	TIRE WIDTH	WHEEL DIAMETER					
32" x 9" R15	FRONT/REAR	30mm	18 kg	10	3	499 kg	
Part Number			TREAD DEPTH Deeper treads have more grip in all conditions	PLY RATING Indicates tire puncture-resistance	LOAD RATING How much weight can the tire handle		
	USAGE Where can you use the tire	TIRE WEIGHT A lighter tire makes for improved vehicle performance		SIDEWALL BELTS Increase your resistance to sidewall punctures			

TIRES BY SIZE

26"	27"
ATTACK	MUD XC
DUAL-THREAT	PRESERVE
HARVESTER	HARVESTER
PRESERVE	WHITEOUT
XD-K	

TIRES BY TERRAIN

TRAIL	ROCK	DESERT	MUD	UTILITY	SNOW
DUAL-THREAT	DUAL-THREAT	DUAL-THREAT	MUD XC	ATTACK	ATTACK
ATTACK	ATTACK	ATTACK		HARVESTER	HARVESTER
HARVESTER				PRESERVE	PRESERVE
PRESERVE				XD-K	XD-K
XD-K					WHITEOUT
MUD XC					

TIRES



PRO ARMOR DUAL-THREAT

- Dual-compound technology and radial construction offer performance in all terrains
- Softer durometer rubber on outer edge for overall superior grip and feel
- Harder durometer rubber in the middle for increase traction during acceleration and longer tread life

	TREAD DEPTH	TIRE WEIGHT	PLY RATING	SIDEWALL BELTS	LOAD RATING
14" 26" x 9" R14 5416340	FRONT	12 kg	10	3	413 kg
	16 mm				
14" 26" x 11" R14 5416341	REAR	14 kg			504 kg



PRO ARMOR ATTACK

- The best all-purpose tire for all-season traction in any terrain
- Unique full-face tread design
- Harder durometer lugs promote extended wear, increasing tire life

	TREAD DEPTH	TIRE WEIGHT	PLY RATING	SIDEWALL BELTS	LOAD RATING
14" 26" x 9" R14 5415613	FRONT	13 kg	8	3	413 kg
	23 mm				
14" 26" x 11" R14 5415614	REAR	15 kg			599 kg



For off-road use only. Please check fitment with your dealer.

COMMON

WINCHES

570

XP 10000 - XP 1000 S

SCRAMBLER XP 1000 S

MISC 8 YOUTH

PLow 6 TRACKS

WHEELS 6 TIRES

LIGHTING

HUNT 6 COOLERS

41

TIRES



PRO ARMOR HARVESTER

- All-around workhorse with tread life of 8,047 kilometers
- Tread pattern designed to withstand anything from the farmyard to the pastures to the trail
- With 10-ply, it can carry the load day-in and day-out

		TREAD DEPTH	TIRE WEIGHT	PLY RATING	SIDEWALL BELTS	LOAD RATING	
12"	26" x 8" R12 5416396	FRONT	11 kg			388 kg	
12"	26" x 10" R12 5415966	REAR	16 mm	15 kg	10	3	615 kg
14"	27" x 10" R14 5415965	FRONT/REAR	15 kg			599 kg	



PRO ARMOR WHITEOUT

- Extra wide tires for flotation in snow
- Tread pattern designed for superior snow traction with limited digging

		TREAD DEPTH	TIRE WEIGHT	PLY RATING	SIDEWALL BELTS	LOAD RATING	
14"	27" x 14" R14 5416032	FRONT/REAR	16 mm	11 kg	8	3	424 kg



PRO ARMOR PRESERVE

- Turf-friendly for areas where low impact from tire tread is needed
- Exceptionally quiet-running and low impact

		TREAD DEPTH	TIRE WEIGHT	PLY RATING	SIDEWALL BELTS	LOAD RATING	
12"	26" x 8" R12 5416403	FRONT	11 kg			388 kg	
12"	26" x 10" R12 5416402	REAR	16 mm	13 kg	10	3	599 kg
14"	27" x 10" R14 5416348	FRONT/REAR	13 kg			599 kg	

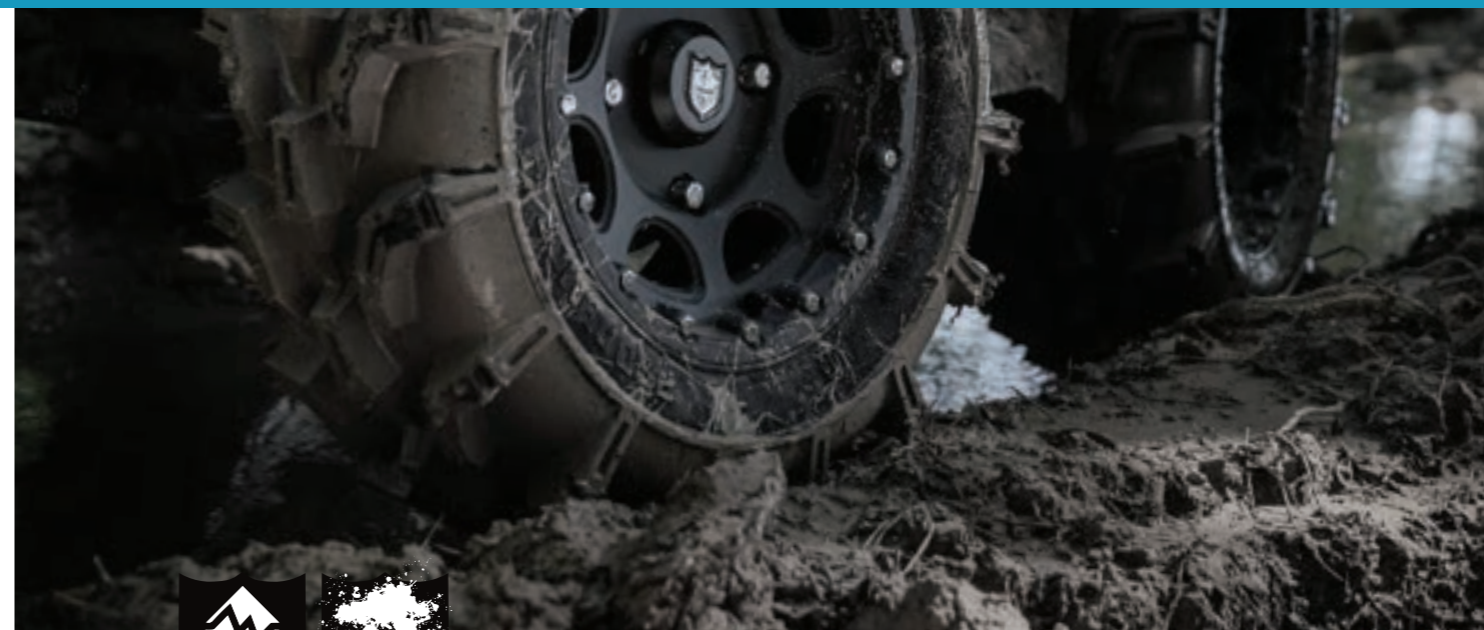

PRO ARMOR XD-K

- 26" Aramid fiber-belted tire can tackle any terrain
- Unique full-face tread design
- Harder durometer lugs promote extended wear, increasing tire life

		TREAD DEPTH	TIRE WEIGHT	PLY RATING	SIDEWALL BELTS	LOAD RATING	
12"	26" x 9" R12 5415756	FRONT	13 kg			388 kg	
12"	26" x 11" R12 5415757	REAR	31.7 mm	15 kg	8	3/1 Aramid	499 kg



PRO ARMOR MUD XC

- Designed as the perfect mud-trail crossover for a smooth ride on the trail and aggressive traction in the mud
- Dual-compound technology with harder durometer lugs promotes extended wear, increasing tire life
- 10-ply construction means added protection in the toughest terrain

		TREAD DEPTH	TIRE WEIGHT	PLY RATING	SIDEWALL BELTS	LOAD RATING	
14"	27" x 9" R14 5416947	FRONT	14 kg			531 kg	
14"	27" x 11" R14 5416948	REAR	30 mm	15 kg	10	3	599 kg



WHEELS



A 4101
WEIGHT: 6.6 kg | **LOAD RATING:** 363 kg | **OFFSET:** -35
MATTE BLACK: FRONT/REAR 14" x 10" 1522958

B 4201
FRONT WEIGHT: 5.9 kg | **LOAD RATING:** 408 kg | **OFFSET:** +4
REAR WEIGHT: 6.4 kg | **LOAD RATING:** 590 kg | **OFFSET:** -9
ACCENT: FRONT 14" x 7" 1522956-266
REAR 14" x 8" 1522957-266
MATTE BLACK: FRONT 14" x 7" 1522956-458
REAR 14" x 8" 1522957-458

C 4202
FRONT WEIGHT: 5.8 kg | **LOAD RATING:** 408 kg | **OFFSET:** +4
REAR WEIGHT: 6.1 kg | **LOAD RATING:** 590 kg | **OFFSET:** -9
ACCENT: FRONT 14" x 7" 1522544-266
REAR 14" x 8" 1522545-266
MATTE BLACK: FRONT 14" x 7" 1522544-458
REAR 14" x 8" 1522545-458

D 4203 BEADLOCK
FRONT WEIGHT: 5.9 kg | **LOAD RATING:** 408 kg | **OFFSET:** +4
REAR WEIGHT: 6.6 kg | **LOAD RATING:** 590 kg | **OFFSET:** -9
MATTE BLACK: FRONT 14" x 7" 1522238-458
REAR 14" x 8" 1522239-458

E 4204
FRONT WEIGHT: 5.9 kg | **LOAD RATING:** 408 kg | **OFFSET:** +4
REAR WEIGHT: 6.4 kg | **LOAD RATING:** 590 kg | **OFFSET:** -9
ACCENT: FRONT 14" x 7" 1522546-266
REAR 14" x 8" 1522547-266
MATTE BLACK: FRONT 14" x 7" 1522546-458
REAR 14" x 8" 1522547-458

F 4205
FRONT WEIGHT: 4.8 kg | **LOAD RATING:** 408 kg | **OFFSET:** +4
REAR WEIGHT: 5.7 kg | **LOAD RATING:** 590 kg | **OFFSET:** -9
MATTE BLACK: FRONT 14" x 7" 1521507-521
REAR 14" x 8" 1521508-521
LUSTER: FRONT 14" x 7" 1521507-410
REAR 14" x 8" 1521508-410

G 4206
FRONT WEIGHT: 4.3 kg | **LOAD RATING:** 408 kg | **OFFSET:** +4
REAR WEIGHT: 4.9 kg | **LOAD RATING:** 590 kg | **OFFSET:** -9
MATTE BLACK: FRONT 14" x 6" 1522542-458
REAR 14" x 8" 1522543-458

H 4301 BEADLOCK
WEIGHT: 7.3 kg | **LOAD RATING:** 726 kg | **OFFSET:** +38
ACCENT: FRONT/REAR 14" x 7" 1523284
MATTE BLACK: FRONT/REAR 14" x 7" 1523283

I HD DUAL BEADLOCK
WEIGHT: 18.1 kg | **LOAD RATING:** 725.7 kg | **OFFSET:** +38
MATTE BLACK: FRONT/REAR 14" x 7" 1524022-458

KNOW YOUR WHEELS

STEP 1: SELECT SERIES
4 = 40-SERIES

STEP 2: CHOOSE LOAD RATING
1 = <362.9 kg
2 = 363 - 589.7 kg
3 = 590 - 726+ kg

STEP 3: PICK STYLE
OFFSET / BEADLOCK / COLOR

INCREASE OFFSET FROM STOCK = NARROWER STANCE
DECREASE OFFSET FROM STOCK = WIDER STANCE

2 WAYS TO PURCHASE INDIVIDUAL WHEELS & TIRES
 - OR -
 COMPLETE SETS AS LISTED

Exclusively at Polaris Authorized Dealers

14" FORGED BEADLOCK RINGS

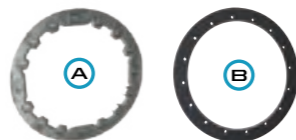

PRO ARMOR FORGED RINGS Sold individually

	PART #
A Machined Only used on 4203 Beadlock & HD Dual Beadlock	1522244-266
B Beadlock Ring - Matte Black - 14" Only used on 4301 Beadlock & HD Dual Beadlock	1523146-458

KNOW YOUR TERRAIN



• Tread patterns optimized for extreme traction
 • Ideal for both hard pack and loose trail



• Extra deep treads
 • Self-cleaning lugs



• Triple-belted sidewalls to resist puncture
 • Purpose-built, long lasting tread patterns



• Handles extreme cold
 • Holds shape and provides traction

WHEEL & TIRE SETS

	TRAIL ATTACK 26"	MUD DUAL-THREAT 26"	MUD XC 27"	UTILITY PRESERVE 27"	UTILITY HARVESTER 27"	SNOW WHITEOUT 27"
40-SERIES						
4101 Matte Black						2882382
4201 Accent	2882390	2883138	2884272	2883208	2882388	
4201 Matte Black	2882391	2883139	2884273	2883209	2882389	
4202 Accent	2881335	2883140	2884267	2883203	2882383	
4202 Matte Black	2881336	2883141	2884268	2883204	2882384	
4203 BEADLOCK Matte Black BEADLOCKS SOLD SEPARATELY	2881381					
4204 Accent	2881347	2883142	2884270	2883205	2882385	
4204 Matte Black	2881348	2883143	2884271		2882386	
4205 Luster	2881359	2883144				
4205 Matte Black	2881360	2883145	2884269	2883207	2882387	
4206 Matte Black	2881404					
4301 BEADLOCK Accent BEADLOCKS PRE-MOUNTED		2883217				
4301 BEADLOCK Matte Black BEADLOCKS PRE-MOUNTED		2883216				

LUG NUTS

LUG NUTS REQUIRED



METRIC LUG NUTS FOR ALUMINUM RIMS

» 2877385 - SET OF 4
 » 2877384 - SET OF 16
 SPORTSMAN XP

SAE LUG NUTS FOR ALUMINUM RIMS

» 2876754 - SET OF 4
 » 2877409 - SET OF 16
 SPORTSMAN 450/570

REPLACEMENT CAPS

CENTER CAP

LUSTER	ALL WHEELS EXCEPT 4204 & 4203 BEADLOCK	1521509-410
MATTE BLACK		1521509-521
HD MATTE BLACK	ALL WHEELS	5457498-458

PRO ARMOR CENTER CAP

LUSTER	ALL WHEELS EXCEPT 4204 & 4203 BEADLOCK	5453209-410
MATTE BLACK		5453209-458



COLBY VALVE SHORT ULTIMATE VALVE - 2 PACK

» 2883292



COLBY VALVE EMERGENCY VALVE - 2 PACK

» 2883293



COLBY COMBO VALVE KIT - 16 PACK

• Includes eight Ultimate Valves and eight Emergency Valves
 » 2883294

ADVANCED TECH

RIGID lights are driven by Aluminum PCB Smart Boards, 6063-T5 aircraft aluminum extruded housings and Tiger Drylac UV protection polyester powdercoating.

EXCLUSIVE OPTICS

RIGID lights feature impact-resistant polycarbonate lenses for a 100% water/dustproof seal.

RUGGED CONSTRUCTION

Pro Armor lights are designed to be big and beefy with an aggressive style all their own, and housed in IP67 marine-grade rated UV polyester powdercoating.

MASSIVELY BRIGHT

Pro Armor builds bright lights designed for any riding experience. All that power is directed through heat dissipating aluminum for streamlined heat management.

LIGHT BAR TYPES



SR-SERIES PRO

Sleek, powerful, low-profile (under 5 cm tall). Lights extreme distances with low energy usage.
Available in 25.4 cm



D-SERIES PRO

Compact to fit almost anywhere with high output and low energy usage.
Available in Driving, Flood & Spot



DUAL-ROW LED LIGHT BARS

The most spread and farthest illumination downrange. Easy to mount.
Available in Cube, 25.4 cm & 50.8 cm



SINGLE-ROW LED LIGHT BARS

Powerful, compact, low-profile light bars with a sleek look.
Available in 27.9 cm & 50.8 cm



CUBE LED LIGHTS

Small size allows mounting in strategic locations for added lighting.
Available in Flood & Spot

LIGHT BAR OPTIONS

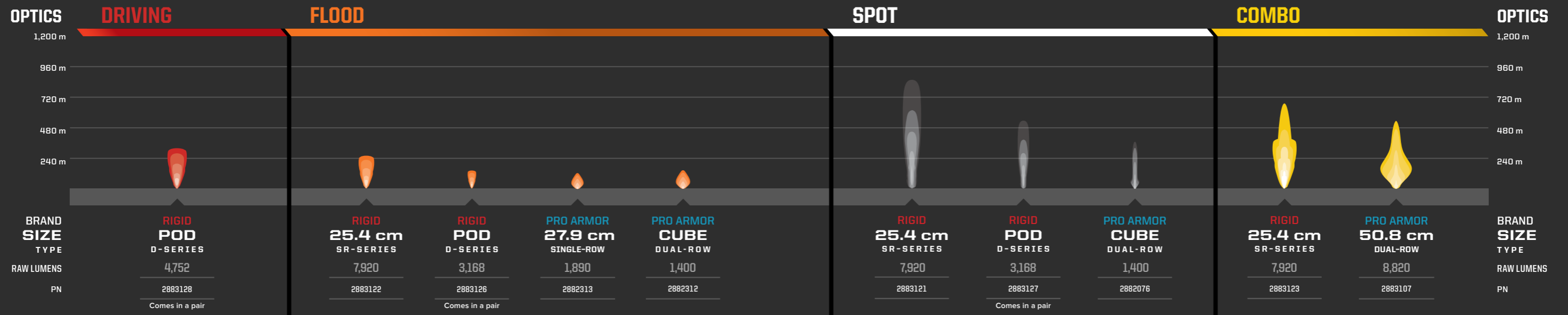

BUILD YOUR VISION

Consider the optics, angle and how you will use your vehicle to choose the right light or set of lights.

OPTICS LIGHT ANGLE	ACCENT	DRIVING (45°)	FLOOD (25°)	SPOT (10°)	COMBO (25°/10°)
DRIVING SPEED	All	Slow	Medium	Fast	Medium to fast
BEAM	Diffused glow	Extra-wide	Wide/Shorter	Concentrated/Long	Inner spot & outer flood
RECOMMENDED MOUNTING	Low/Wheel well	All points	Low &/or rear	High points	All points
TERRAIN & RIDING STYLE	Added style & personalization in any terrain	All riding & utility	Wide-open terrain or trails & utility	Trail & tight conditions	All riding & utility

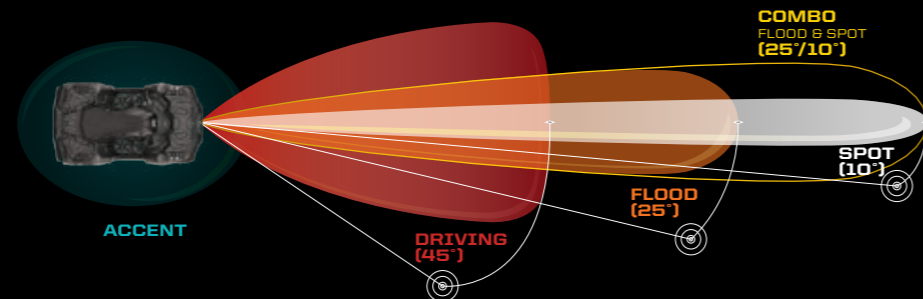

POLARIS ENGINEERED



LED LIGHTING

LED LIGHT KIT

• Upgrade your standard headlights and pod lights to LEDs with this upgrade kit
» 2884859
SPORTSMAN XP 1000 S '21-22, SPORTSMAN 850/1000 '21-22, SPORTSMAN 450/570 '21-22

WIRING HARNESSES

LIGHTBAR HARNESS

• Control one light with one switch
» 2882320
ALL SPORTSMAN MODELS

LED Y-HARNESS

• Requires 2882320 to control two cubes or two lights with one switch
» 2879860
ALL SPORTSMAN MODELS

PROTECTING YOUR ESSENTIAL GEAR SINCE 1943



Never transport a loaded firearm. Verify firearm is unloaded prior to mounting. Please refer to local laws and regulations regarding the requirements for the legal transport of firearms.

KOLPIN STRONGHOLD SYSTEM

Polaris is proud to partner with Kolpin Outdoors, an industry leader in off-road accessories and the premier name in gun boots and mounts. If you need to secure a firearm while riding, simply attach the auto-latch mount and choose your Gun Boot.

IDEAL FOR SECURE TRANSPORT OF SCOPED RIFLES AND SHOTGUNS

STEP 1 CHOOSE YOUR MOUNT



STRONGHOLD AUTO-LATCH MOUNT

- The auto-latching design provides quick and secure Kolpin Stronghold product attachment
- Bracket is made from rugged high impact, reinforced nylon and coated steel with precision angle adjustment for a custom fit
- For use with the Kolpin Stronghold line of products (sold separately)

» 2882272
SPORTSMAN 850/1000 '17-22
Does not fit with Ultimate Series – Body Armor (2882090)

STRONGHOLD AUTO-LATCH MOUNT

- The Auto-latching design provides quick and secure Kolpin Stronghold product attachment
- Bracket is made from rugged high impact, reinforced nylon and coated steel with precision angle adjustment for a custom fit
- For use with the Kolpin Stronghold line of products (sold separately)

» 2884846
SPORTSMAN 450/570 '21-22

STEP 2 CHOOSE YOUR BOOT



GUN BOOT L

- 132.1 cm L x 12.1 cm W x 23.5 cm H
- Requires Auto-Latch Mount 2882272 or 2884846 to mount to vehicle

» 2882426
SPORTSMAN 850/1000 '17-22,
SPORTSMAN 450/570 '14-22

GUN BOOT XL

- Lockable and TSA Approved
- Includes padded, zippered internal protective liner
- 132.1 cm L x 9.5 cm W x 26.6 cm H
- Requires Auto-Latch Mount 2882272 or 2884846 to mount to vehicle

» 2882036
XP 1000 '17-22, 850 '17-22, 570 '19-22, 450 H.O '21-'22



KOLPIN RHINO GRIP

IDEAL FOR CARRYING RIFLES, SHOTGUNS, BOWS AND CROSSBOWS.



LOCK & RIDE RHINO GRIP PRO

- » 2884119
- » 2884109 • REPLACEMENT RUBBER STRAPS
ALL SPORTSMAN MODELS
(EXCEPT UTILITY EDITIONS & YOUTH)



LOCK & RIDE RATCHETING RHINO GRIP

- » 2881157
ALL SPORTSMAN MODELS (EXCEPT UTILITY AND YOUTH)



LOCK & RIDE RHINO GRIP XLR

- » 2889147
- » 2889204 • RHINO GRIP XLR
REPLACEMENT RUBBER STRAPS (2)
ALL SPORTSMAN MODELS
(EXCEPT UTILITY EDITIONS & YOUTH)



LOCK & RIDE RHINO GRIP XLR – DOUBLES

- » 2889148
- » 2889204 • RHINO GRIP XLR
REPLACEMENT RUBBER STRAPS (2)
ALL SPORTSMAN MODELS
(EXCEPT UTILITY EDITIONS & YOUTH)



KOLPIN GUN BOOT IV

- For 50mm scopes, rifles with slings attached, or shotguns up to 129.54 cm in length
- » BLACK • 2872677



LOCK & RIDE GUN BOOT MOUNTS

- Works with Lock & Ride XL Storage Box, Lock & Ride Rear Cargo Box, and Rear Rack Extenders
- » 2878001
SPORTSMAN 850/1000 TOURING '10-22
Only Compatible with Kolpin Gun Boot IV – Not Compatible with Kolpin Stronghold Gun Boots

KEEP IT ICE COLD



GRIZZLY TESTED. POLARIS APPROVED.



This cooler is IGBC-approved, meaning it withstands the power expended by a typical grizzly bear if it was trying to get inside.

Seriously, there are experts who know what a grizzly is capable of doing, and they certify our coolers can take it.



28, 57 & 99
LITER FEATURES



Comfort Carry Handles



TravelLock System



EasyOut Drain System



NoSlip Rubber Feet



PolarWall Insulation



IceLock Seal

POLARIS NORTHSTAR COOLERS CAN SURVIVE JUST ABOUT ANYTHING - FROM EXTREME HEAT TO A NASTY TUMBLE OFF A VEHICLE.



99 LITER

- » GRAPHITE • 2883426
- » DESERT • 2883392



57 LITER

- » GRAPHITE • 2883425
- » DESERT • 2881259



28 LITER

- » GRAPHITE • 2883424
- » DESERT • 2881315



14 LITER









- » GRAPHITE • 2883968

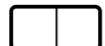

**NEW 19 LITER
SOFT-SIDED COOLER**

- » GRAPHITE • 2889285

ESSENTIAL ACCESSORIES SO YOUR COOLER WORKS AS HARD AS YOU DO

COOLER ACCESSORIES		99 LITER	57 LITER	28 LITER	DON'T FORGET THESE ACCESSORIES	
	WIRE BASKET	2883648	2882185	2882438	 <p>TUMBLERS</p> <ul style="list-style-type: none"> » 887 mL • 2883394 » 591 mL • 2883393 	 <p>BOTTLE OPENER</p> <ul style="list-style-type: none"> » 2882183 ALL COOLERS
	DIVIDERS Doubles as cutting board	2883468 COMES WITH ONE DIVIDER  1 way to partition	2882184 COMES WITH TWO DIVIDERS  2 ways to partition	2882186 COMES WITH ONE DIVIDER  1 way to partition		
	SEAT CUSHION	NOT AVAILABLE	2882179	2882507		
	WHEELS	2883967	2882180	NOT AVAILABLE		

FOR THE LIFE OF YOUR RIDE

PARTS THAT PUSH THE LIMITS WITHOUT SACRIFICING STRENGTH AND DURABILITY.

We build our products so anyone with the right tools can maintain their vehicle.

POLARIS

ENGINEERED PARTS & LUBRICANTS

PARTS & GARAGE

MAINTENANCE

OIL & LUBRICANTS

HO PARTS

SERVICE PARTS

CLEANERS & TRAILERING

MAINTENANCE TIP

BREAK-IN PERIOD

The break-in period for your new SPORTSMAN is the first 25 hours of operation, or the time it takes to use the first two tanks of fuel. No single action on your part is as important as a proper break-in period. Careful treatment of a new engine will result in more efficient performance and longer life for the engine.

NOTICE: Excessive heat build-up during the first three hours of operation will damage close-fitted engine parts. Do not operate at full throttle or high speeds for extended periods during the first three hours of use.

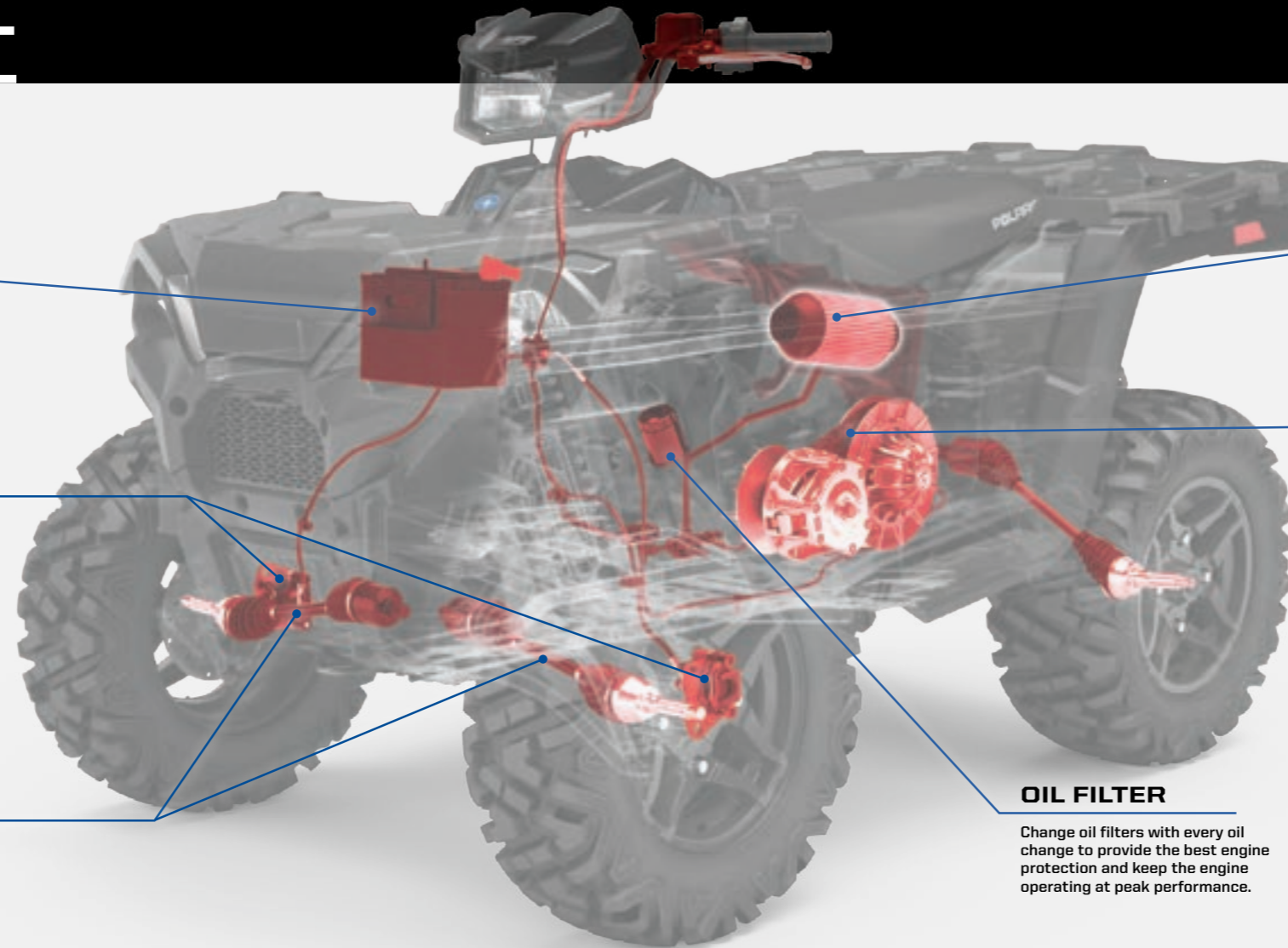

BATTERY

To ensure a battery maintains its level of charge when unused for extended periods of time or during freezing weather, the battery should be connected to a suitable battery charger. Be sure to check for corrosion from the terminals to the ends of the cables.

BRAKE PADS

Maintaining and/or replacing brakes are critical to the safety and functionality of a vehicle. Brake pads should be checked for wear and oil or grease (petroleum products) contamination and brake discs should be checked for cracks, excessive corrosion or warping.

HALF SHAFT

Check for tears and punctures in the boot, which can lead to CV joint wear that can contribute to axle failure.

AIR FILTER

A clogged air filter can restrict air flow to the engine leading to reduced engine performance, engine life or catastrophic failure.

DRIVE BELT

Polaris Engineered belts deliver unmatched performance for your off-road vehicle. Developed and tested on all our engines for all environments and conditions. Check your belt for delamination, hour glassing and glazing.

BREAK-IN PERIOD

- Use lower gear (if available) while varying speeds and avoid wide open throttle for 8-16 km
- If no low gear is available, vary at moderate speeds while avoiding wide open throttle for 80 km

OUR INVESTMENT

- 32,187 km of field testing
- Thousands of dyno hours
- 18+ months of development (13,000+ design hours) per belt
- 1,500+ vehicle validation hours
- Collaboration with powertrain and clutch engineers

YOUR ADVANTAGE

- No clutch recalibration
- Less wear and tear due to heat
- Ensure maximum vehicle performance
- More time riding, less time wrenching
- Produced in collaboration with powertrain and clutch engineers to ensure a perfect fit, maximum performance and ultimate durability

OIL FILTER

Change oil filters with every oil change to provide the best engine protection and keep the engine operating at peak performance.

FOLLOW RECOMMENDED SERVICE INTERVALS IN THE OWNER'S MANUAL

MAINTENANCE SCHEDULE

25 HRS / 400 km

BREAK-IN MAINTENANCE

- ENGINE OIL:** CHANGE
- GEARCASES:** CHECK OIL LEVEL
- AIR FILTER:** INSPECT & REPLACE AS NEEDED
- EXHAUST SYSTEM:** INSPECT & CLEAN
INSPECT FOR LEAKAGE OR CARBON BUILD UP AT JOINTS
INSPECT & CLEAN SCREEN TYPE SPARK ARRESTOR

50 HRS / 800 km

6 MONTHS

- EXHAUST SYSTEM:** INSPECT & CLEAN
INSPECT FOR LEAKAGE OR CARBON BUILD UP AT JOINTS
INSPECT & CLEAN SCREEN TYPE SPARK ARRESTOR
- GENERAL LUBRICATION:** ALL FITTINGS, PIVOTS, CABLES, ETC.
- DRIVE BELT:** INSPECT & ADJUST
REPLACE AS NEEDED

100 HRS / 1,600 km

12 MONTHS

- ENGINE OIL:** CHANGE
- DRIVE BELT:** INSPECT & ADJUST
REPLACE AS NEEDED
- SPARK PLUGS:** REPLACE
- EXHAUST SYSTEM:** INSPECT & CLEAN
INSPECT FOR LEAKAGE OR CARBON BUILD UP AT JOINTS
INSPECT & CLEAN SCREEN TYPE SPARK ARRESTOR

150 HRS / 2,400 km

18 MONTHS

- BATTERY:** TEST, CLEAN & CHECK FLUID LEVEL
IF NECESSARY, REPLACE AS NEEDED
- DRIVE BELT:** INSPECT & ADJUST
REPLACE AS NEEDED
- TIRES:** INSPECT CONDITION & PRESSURE
- EXHAUST SYSTEM:** INSPECT & CLEAN
INSPECT FOR LEAKAGE OR CARBON BUILD UP AT JOINTS
INSPECT & CLEAN SCREEN TYPE SPARK ARRESTOR

200 HRS / 3,200 km

24 MONTHS

- ENGINE OIL:** CHANGE
- TRANSMISSION FLUID:** CHANGE
- GEARCASES:** CHECK OIL LEVEL
- BRAKE PADS & FLUID:** INSPECT & CLEAN
REPLACE AS NEEDED
- SPARK PLUGS:** REPLACE
- EXHAUST SYSTEM:** INSPECT & CLEAN
INSPECT FOR LEAKAGE OR CARBON BUILD UP AT JOINTS
INSPECT & CLEAN SCREEN TYPE SPARK ARRESTOR

250 HRS / 4,023 km

30 MONTHS

- ENGINE OIL:** CHANGE
- BATTERY:** TEST, CLEAN & CHECK FLUID LEVEL
REPLACE AS NEEDED
- DRIVE BELT:** INSPECT & ADJUST
REPLACE AS NEEDED
- GENERAL LUBRICATION:** ALL FITTINGS, PIVOTS, CABLES, ETC.
- EXHAUST SYSTEM:** INSPECT & CLEAN
INSPECT FOR LEAKAGE OR CARBON BUILD UP AT JOINTS
INSPECT & CLEAN SCREEN TYPE SPARK ARRESTOR

300 HRS / 4,828 km

36 MONTHS

- ENGINE OIL:** CHANGE
- AIR FILTER:** INSPECT & REPLACE AS NEEDED
- GEARCASES:** CHECK OIL LEVEL
- SPARK PLUGS:** REPLACE
- EXHAUST SYSTEM:** INSPECT & CLEAN
INSPECT FOR LEAKAGE OR CARBON BUILD UP AT JOINTS
INSPECT & CLEAN SCREEN TYPE SPARK ARRESTOR

CHECK YOUR OWNER'S MANUAL FOR ADDITIONAL RECOMMENDED SERVICE ITEMS AND VEHICLE-SPECIFIC TIMING

POLARIS

**ENGINEERED PARTS
& LUBRICANTS**

**FOR THE LIFE OF YOUR RIDE
ONLY THE BEST WILL DO**

To create the best oil for any terrain, we invest in rigorous testing to ensure our oil delivers the consistency and performance you demand. The results are Polaris Engineered Lubricants that are tested and perfected to deliver excellent total engine protection for the life of your ride.

WHAT COUNTS IN OIL TESTING:

1. Does it protect the engine at high temperatures?
2. Does it keep the engine free from carbon and buildup?
3. Does the oil hold its viscosity over time?

ENGINE CHECKPOINTS

When evaluating an engine oil and its ability to protect and preserve the engine's power output and lifespan, Polaris engineers focus on key areas within the engine, some of the most critical ones include:

RING LANDS: Poor oxidative performance can lead to carbon and varnish buildup, which results in poor ring seal and loss of power, combustion blow by and fuel dilution of the oil.

PISTON RINGS: During the combustion process, extreme pressures are placed on the top ring, forcing it outward toward the cylinder wall, sealing the combustion chamber. With so much force applied, poor oil film strength between the top ring and the cylinder wall can lead to cylinder wear and loss of power.

ROD BEARINGS: Engine bearings ride on an extremely thin hydrodynamic film of oil. Poor oil film strength or using an oil with a thinner viscosity, can lead to premature bearing wear or even engine failure. Using an oil with high film strength and a strong viscosity, like PS-4 full synthetic, will extend the service life of your engine.

CAMSHAFT: Direct Acting Overhead Camshafts are used on many Polaris Prostar Engines. In this application the camshaft pushes directly on the valve, creating very high contact pressures compared to other camshaft configurations. These forces are so great that inferior oil can break down and be forced out of the contact area leading to increased wear. PS-4 full synthetic additives are specifically designed to provide wear protection against this.

OIL DEVELOPMENT

**12 DEDICATED
TEAM MEMBERS**

**18+
MONTHS**

**FOCUSED ON
POLARIS OIL**

**DEVELOPMENT
& TESTING**

**64,374
KILOMETERS**

**75,000+
HOURS**

**FIELD
TESTING**

**DYNO
TESTING**



**SPECIFIC NEEDS,
SPECIFIC OILS**

Polaris invests millions in engine development, and part of that investment is making sure its lubricants—critical to engine performance—are the right formula for your specific engine. The amount of testing data and engineering resources used in developing Polaris lubricants would overwhelm an aftermarket company. Therefore, the aftermarket must spec an oil to an industry-wide standard that must account for a variety of operating parameters.

PS-4 is designed specifically for Polaris 4-cycle engines and has high film strength and wear protection under extreme loads and temperatures. Exclusive anti-wear additives protect engine parts with extra rust and corrosion protection.

**PS-4 SYNTHETIC
PERFORMANCE OIL**

• PS-4 is optimal for ambient operating temperatures of -40° C to 40° C

- » 1L • 502484
- » 4L • 502485
- » 25 L • 502486
- » 60 L • 502487
- » 200 L • 502488

**PS-4 EXTREME-
DUTY SYNTHETIC
PERFORMANCE OIL**

• PS-4 Extreme Duty is optimal for ambient operating temperatures of -20° C to 55° C

- » 1L • 502491
- » 4L • 502492
- » 25 L • 502494
- » 60 L • 502496
- » 200 L • 502497

PS-4 OIL CHANGE KIT

• Contains the correct amount of oil for your vehicle and correct oil filter

- » 502541
SINGLE 570, TWIN 600, TWIN 700, TWIN 800
- » 502543
RANGER/RZR 900/1000
- » 502542
330500, SPORTSMAN 550/850/1000

**ENGINEERED TO MAXIMIZE
THE LIFE OF YOUR RIDE**

All Polaris fluids—from anti-freeze to brake fluid—are developed for your vehicle. Trust the only fluids perfectly engineered for your needs.

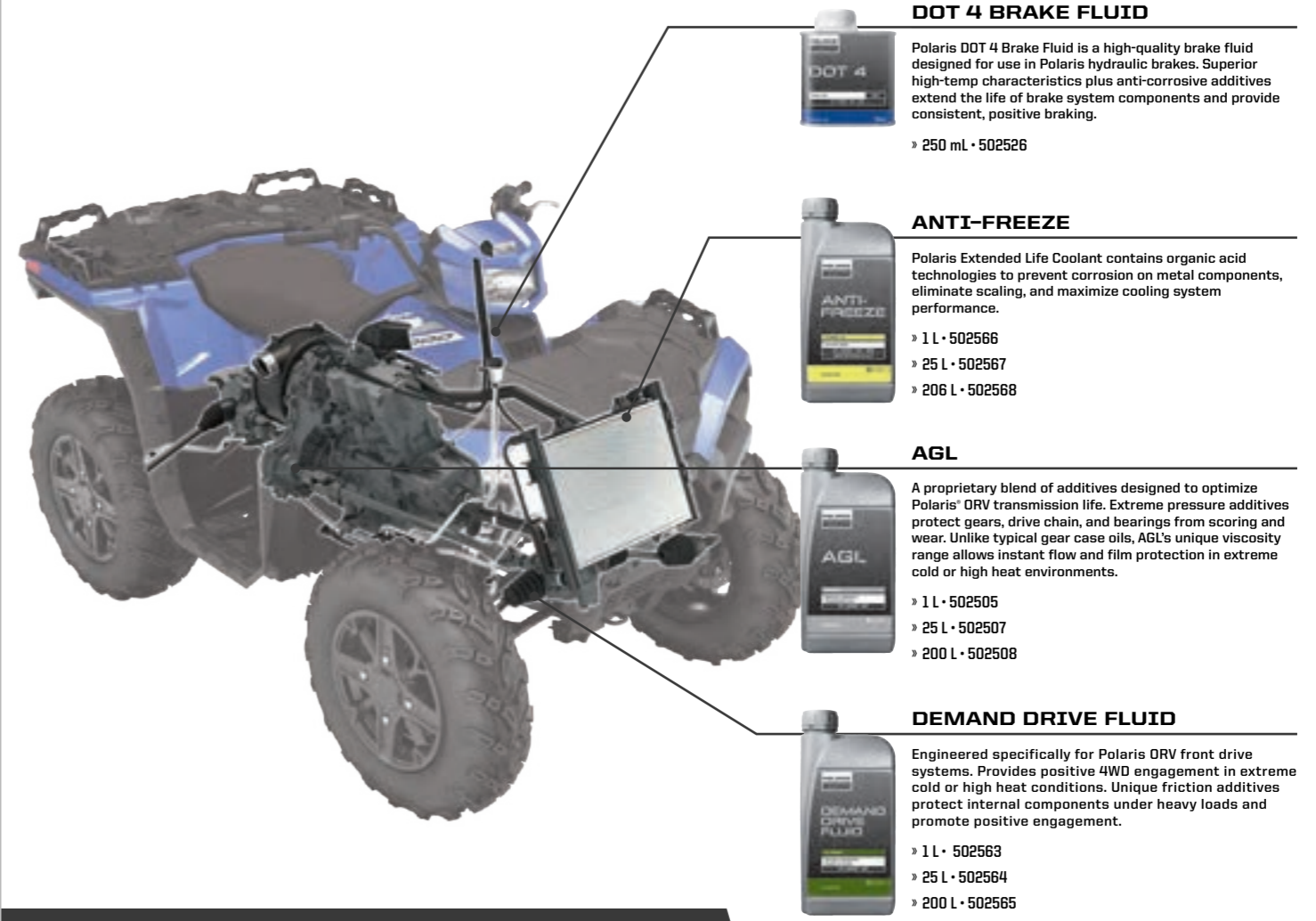

Proper lubricant application and timing will ensure optimal vehicle performance. Please refer to your owner's manual for lubricant change interval schedules.

<p>CARBON CLEAN</p>  <p>Polaris Carbon Clean prevents ethanol corrosion, stabilizes fuel, and cleans fuel injectors, piston ring lands, intake systems, and combustion chambers. Helps maintain peak HP and improves fuel economy. » 125 mL • 502528</p>	<p>FUEL STABILIZER</p>  <p>Fuel Stabilizer prevents ethanol corrosion and stabilizes fuel for up to 2 years. Dual-antioxidant formula protects against gum and varnish for easy starting. » 125 mL • 502519</p>	<p>ANGLE DRIVE FLUID</p>  <p>» 1L • 502510 » 25 L • 502511 » 202 L • 502512 SPORTSMAN, RANGER, RZR ANGLE DRIVE GEAR CASE SYSTEMS</p>	<p>PREMIUM GAS SHOCK OIL</p>  <p>» 1L • 502518</p>
<p>ALL-SEASON GREASE TUBE</p>  <p>» 400 g • 502538</p>			

PARTS & GARAGE

MAINTENANCE

OIL & LUBRICANTS

HO PARTS

SERVICE PARTS

CLEANERS
& TREATING

HD HEAVY DUTY PARTS



All Polaris parts are developed and tested to help you get the most out of your ride. We're taking the passion of our riders, workers and outdoor enthusiasts to the next level with HD Parts.

Engineered and designed for:

- Greater durability
- Enhanced performance
- Greater wear and tear capabilities
- All weather conditions

NEW OIL FILTERS

The advanced synthetic material built into these filters offers the highest debris holding capacity, maintains oil flow and maximizes performance.

OE	HD HEAVY DUTY PARTS
2520799	2522485
2540086	2522498

WHEEL BEARINGS

Fully sealed for added protection against intrusions. Made of a higher grade steel for extended life in extreme conditions.

LOCATION	OE	HD HEAVY DUTY PARTS
FRONT WHEEL BEARINGS	3514822	3515090
	3514634	3515088
REAR WHEEL BEARINGS	3514917	3515087

WHEELS & TIRES

Class leading durability for off-road performance and traction for confident driving in extreme conditions.

- » 1524022-458 • HD WHEEL - 14x7
- » 5457498-458 • HD WHEEL CENTER CAP

NEW DRIVE BELTS

The enhanced rubber material compound in these belts keep them cool in extreme heat, while our patented cord treatment process maximizes the transfer of horsepower to the ground for those customers hauling heavy loads.

OE	HD HEAVY DUTY PARTS
3211149	3212326
3211077	3212328
3211113	3212332
3211160	3212331

BUSHINGS

The advanced material compound of the bushings enables tighter tolerances to reduce overall wear on the system, while the superior triple lip sealing prevents intrusion of the elements.

LOCATION	OE	HD HEAVY DUTY PARTS
FRONT UPPER BUSHINGS	5439874	1543367
FRONT LOWER BUSHINGS	5439874	1543367
	5436973	1543326
REAR UPPER BUSHINGS	5439874	1543367
	5438895	1543326
REAR LOWER BUSHINGS	5439874	1543367
	5436973	1543326

BRAKES

Engineered to provide longer life and better stopping power while riding in extreme conditions.

LOCATION	OE	HD HEAVY DUTY PARTS
FRONT	2205949	2208933
FRONT/REAR	2202413	2208934
	2202412	2208935

BUSHING KITS

Easily update the entire front and rear suspension.

- » 2830562 (SHOWN)
570 EFI '16-'20, 570 EFI X2 '16-'20, 570 EFI TOURING '16-'20, 570 EPS UTILITY '20, 450 HO '16-'20, 450 UTILITY '20
- » 2830563
570 SP '16-'19, 570 PREMIUM '19, 570 SP TOURING '16-'20

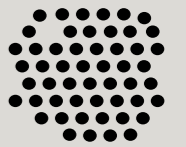
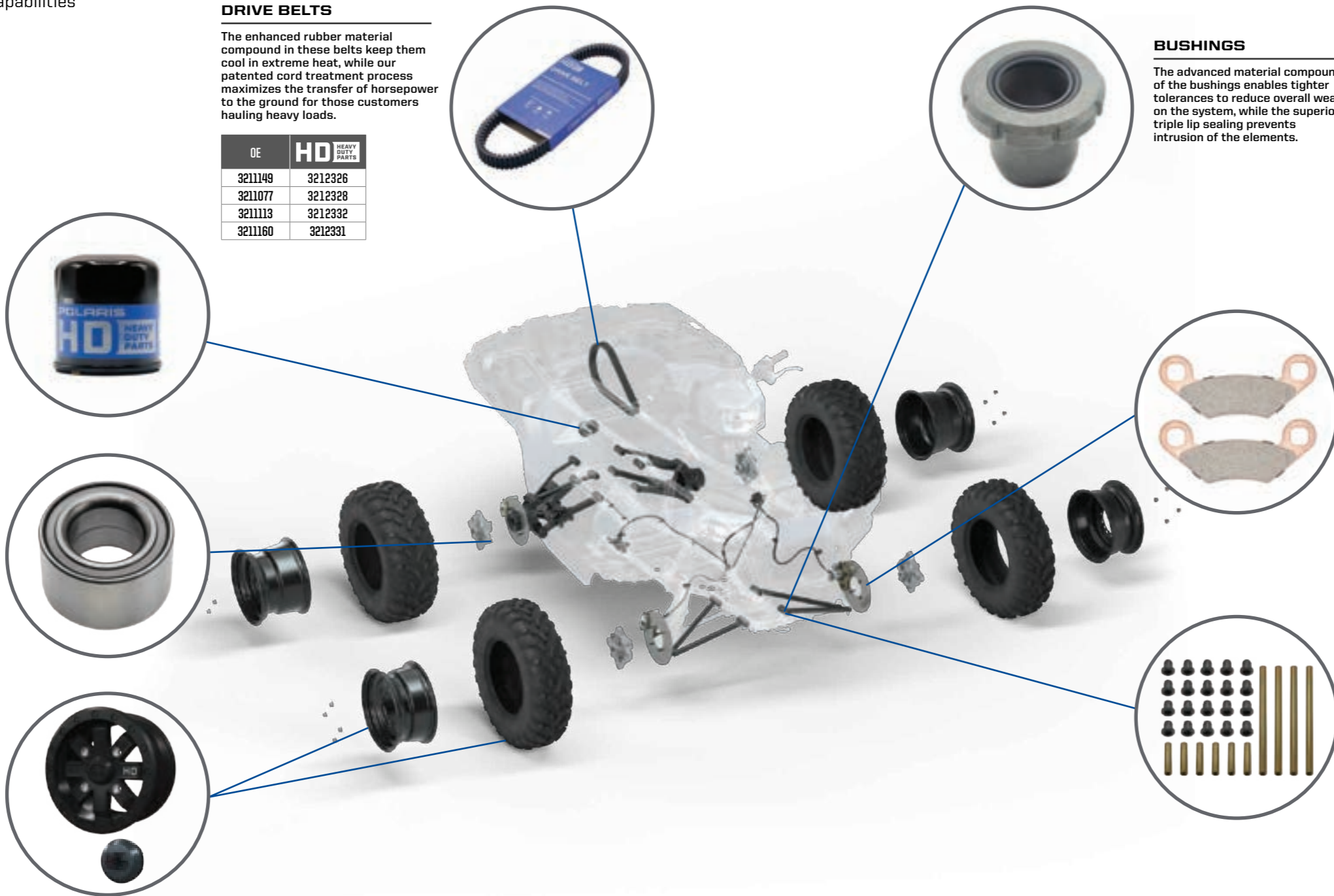

SAND



MUD



WATER



EXTREME COLD



EXTREME HEAT UP TO 54° C



HEAVY PAYLOADS

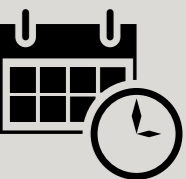

EXTENDED LIFE

SERVICE PARTS

Polaris Engineered service parts deliver unmatched performance and fit for your off-road vehicle.

All service parts are engineered specifically for your machine. Which means everything is designed, tested and perfected to maximize the life of your ride. Getting Polaris Engineered parts is a decision that pays off in the long run, because it ensures there is a long run.



VISIT YOUR POLARIS DEALER TO SHOP FOR SERVICE PARTS.

**OVER
100,000
PARTS
AVAILABLE!**



FOR THE LIFE OF YOUR RIDE

Maintenance is the key to keeping your Polaris off-road vehicle performing at its peak. Items like belts, lubricants, and batteries represent only a few of these critical items engineered specifically by Polaris.



POLARIS ENGINEERED DRIVE BELTS

TESTED, PERFECTED

We test each belt on the intended vehicle – we don't just try to make an existing belt "just work".

– Amery Kuhl, Polaris CVT System Engineer

OUR INVESTMENT

- 32,187 km of field testing
- Thousands of dyno hours
- 18+ months of development (3,000+ design hours) per belt
- 1,200+ vehicle validation hours
- Collaboration with powertrain & clutch engineers

YOUR ADVANTAGE

- No clutch recalibration
- Less wear & tear due to heat
- Ensure maximum performance of your vehicle
- More time out riding, less time wrenching

**OUR INVESTMENTS ENSURE POLARIS BELTS
OUTPERFORM YOUR EXPECTATIONS.**

CV BOOT REPAIR KIT*

FIX ON THE GO | TEMPORARY COVERAGE

- A quick trail-side fix to increase trail time
- The flexible and durable boot material expands "over a cone tool for CV boot repairs, without disassembling CV axles
- Universal fit - works as a temporary fix for most powersports axles
- All components fit inside the cone, and a cover is provided for compact durable storage
- Easily fits in a cargo box, attached to the roll cage, in the glovebox or many other storage locations



Items shown are contained inside cone

ATV CV BOOT REPAIR KIT

Kit includes the following items:

- (1) Expandable CV Boot
- (1) Reusable Cone Tool
- (2) CV Boot Clamps
- (1) Tube of Silicone Lube
- (1) Grease Packet
- (1) Cone Cover

» 2830528

ATV TRAIL BOOT ONLY

» 2830529

UTV

- CV REPAIR KIT 2830526
- TRAIL BOOT ONLY 2830527

HOW TO INSTALL

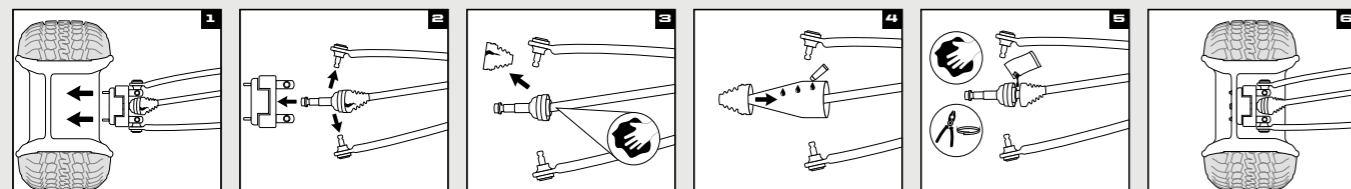

- Remove wheel and axle nut.
- Remove brake caliper, hub, tie rod and upper and lower ball joints.
- Remove old boot and clean joint.
- Spread silicone lube on entire cone tool. Slide boot over cone tool, large end first. See package for outer boot instructions.
- Empty the bag of grease into the CV joint/boot, clean sealing points and install clamps.
- Reassemble tie rod, ball joints, brake caliper, axle nut, tire and wheel.

Refer to your service manual for further instructions and torque specifications.
*Designed for temporary CV boot repair. Purchase the OEM CV Boot for a permanent repair.

KEEP IT CLEAN

CLEAN

ALL-PURPOSE CLEANER

- Professional cleaner, which is formulated with a low pH-value. The product spreads well on surfaces and adheres on them for effective cleaning action. Perfectly compatible with rubber, plastic and painted surfaces. The formulation is biodegradable.

» 500 mL • 502309

SHINE

INSTANT SHINE & DETAILER

- The INSTANT SHINE AND DETAILER is developed for cleaning action without water. Removes insects, dust and dirt with almost no effort. Applicable for plastics, visors, windscreens, paint and metal. The wipe and shine formulation makes surfaces shine, works water repellent and also has an antistatic effect. Perfect for customers living in urban areas with no access to water, for bike trips or showroom bikes.

» 500 mL • 502303



TRAILERING



CALIBER RAMP PRO

- Designed for ATVs and UTVs up to 127 cm wide
 - Integrated grip glides for ultimate traction
 - Folding sides for easy transportation and storing
- » 132 cm x 229 cm • 2884576



ALUMINUM ARCHED LOADING RAMP

- Capacity for up to 1,361 kg
- » 193 cm x 30.5 cm • 907 kg • 2875384
» 224 cm x 30.5 cm • 1,361 kg • 2875386

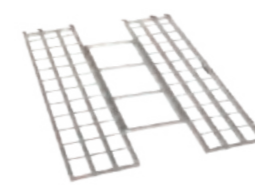

LIGHTWEIGHT TRI-FOLD RAMP

- Ramp folds up for transport
 - Capacity for up to 680.7 kg
 - Safety straps included
- » 183 cm x 130 cm • 2875385
» 208 cm x 130 cm • 2875860



FOLDING ALUMINUM ARCHED RAMP

- Ramp folds up for transport
 - Up to 680 kg total capacity, 340 kg per individual ramp
 - Safety straps included
- » 224 cm x 30.5 cm • 2875387

HITCHES

3:1 HITCHES VERSATILE 3 IN 1 FUNCTIONALITY

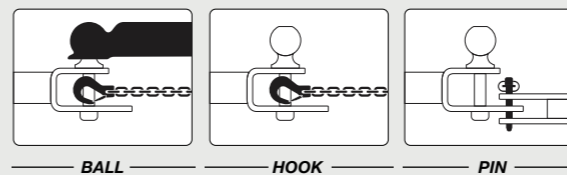

- Ball, hook and pin design
- Durable, rust resistant steel with black powdercoated finish
- Removable ball
- HD 1.6 cm pin and clip



HITCH WITH 5 cm BALL

- 5 cm x 5 cm RECEIVER 2830522
- 3 cm x 3 cm RECEIVER 2830523



4.8 cm BALL

- 4.8 cm replacement ball for hitch
 - Designed to work with 3:1 Hitch
- » 2830524



RECEIVER HITCH

- 5 cm RECEIVER TONGUE 2875320



TRAILER BALL AND SHANK

- 4.8 cm BALL • 2877602
- 5 cm BALL • 2877603

STRAPS & ROPES



RECOVERY STRAP

- 5 cm x 9.1 m
 - 8,165 kg maximum load / 4,082 kg maximum vehicle weight
 - Comes with carry bag
- » 2884033



RATCHET STRAP

- 3.8 cm x 4.6 m straps, 2 Pack
 - Heavy duty webbing
 - 2,495 kg maximum load, 831 kg working load
- » 2884031



RATCHET STRAP

- 5 cm x 6.1 m Ratchet Straps
 - Heavy duty webbing, floating D-rings, double J-hooks
 - 4,536 kg maximum load, 1,497 kg working load
- » 2884032



SHOCK STRAPS

- 3.8 cm 1,361 kg breaking strength
 - Keeps tension on tie-down straps to secure load, 2 Pack
- » 3.8 cm x 4.6 m • 2883296
» 3.8 cm x 2.1 m • 2883295

COVERS

TRAILERABLE COVER

- 2876614 SPORTSMAN 450/570, SPORTSMAN 850/1000 REPLACEMENT STRAP 2871912.
- 2877999 ALL SPORTSMAN TOURING REPLACEMENT STRAP 2871912.
- 2884188 XP 1000 S, SCRAMBLER XP 1000 S





TECHNICAL JACKET

- Water-resistant jacket
- Ultra-light thanks to polyester ripstop and softshell for optimal comfort
- Ventilated lining
- Hydration hose outlet
- Zip ventilation system on body and back

Black | S-3XL | 2802001



TECHNICAL PANTS

- Water-resistant pants
- Ultra-light thanks to polyester ripstop, softshell and 1000-D Cordura Stretch fabric on the back for optimal comfort
- 2 cargo type pockets
- Zip ventilation system
- Zip and Velcro adjustment at the bottom of the pants

Black | S-3XL | 2802002



RACING SOFTSHELL

- Softshell waterproof and breathable 3000mm/3000g
- Removable hood
- Four external pockets with easy-grab puller

Black | S-3XL | 2802003



HYBRID JACKET

- Sleeves in softshell waterproof and breathable 3000mm/3000g
- Body nylon downproof
- Padding 80 g
- Three external pockets with easy-grab puller

Black | S-3XL | 2802004



NEW TECHNICAL SHIRT

- 100% polyester
- Indelible sublimated graphics
- Hemmed edging
- Lycra cuffs and collar

Black | S-3XL | 2802104



NEW BODYWARMER

- Upper body and side panels in softshell waterproof and breathable 3000mm/3000g
- Lower body Nylon downproof
- Padding 80 g
- Two external pockets with easy-grab puller

Black | S-3XL | 2802101



RAIN JACKET

- Polyester ripstop high tearing resistance
- PU coating 1000 mm
- Mesh lining
- Non-removable hood

Black | S-3XL | 2802005



NEW SAFETY GLOVES TOUCH CE

- CE-approved motorcycle glove EN 13594:2015
- Touch screen compatible
- Silicon print on fingers to improve grip
- Neoprene cuff with Velcro tightening
- Reinforcements patches for safety and comfort

Black | XS-7, 3XL-13 | 2802103



NEW SF TECH GLOVES TOUCH CE

- CE-approved motorcycle glove EN 13594:2015
- Touch screen compatible
- Knuckle-protected
- Silicon print on fingers to improve grip
- Neoprene cuff with Velcro tightening
- Reinforcements patches for safety and comfort

Black | XS-7, 3XL-13 | 2802102



NEW

OFF-ROAD RIDING JERSEYS

Mesh ventilated panels for maximum airflow
Elastic sleeves with non-restrictive cuffs

NEW

OFF-ROAD RIDING GLOVES

Adjustable wrist closure for a custom fit
Silicon finger grips and neoprene knuckle protection



BLACK

JERSEY | S-3XL | 2862718
GLOVE | S-3XL | 2862726

YOUTH JERSEY
S-XL | 2862723

ORANGE

JERSEY | S-3XL | 2862719
GLOVE | S-3XL | 2862729

TEAL

JERSEY | S-3XL | 2862720
GLOVE | S-3XL | 2862727

YOUTH JERSEY
S-XL | 2862724

GREEN

JERSEY | S-3XL | 2862721
GLOVE | S-3XL | 2862730

BLUE

JERSEY | S-3XL | 2862722
GLOVE | S-3XL | 2862728

YOUTH JERSEY
S-XL | 2862725



SHORT SLEEVE

Men's | S-3XL | 2860634
Women's | S-3XL | 2860636

LONG SLEEVE

Men's | S-3XL | 2860638
Women's | S-3XL | 2860640

COOLING SHIRTS

FABRIC TECHNOLOGY DESIGNED TO KEEP YOU COOL

- Chemical-free fabric, Coolcore reduces the surface temperature up to 30% so you don't overheat
- Carries a 50 Ultraviolet Protection Factor rating, blocking 98% of harmful UV rays



RAIN JACKET

Gray | S-3XL | 2869527

RAIN PANTS

Gray | S-3XL | 2869528

RAIN JACKET & PANTS

PACKABLE WATERPROOF PROTECTION AGAINST UNPREDICTABLE WEATHER

- 100% waterproof, lightweight and packable nylon
- YKK zippers
- Rain jacket has removable hood

HELMETS

FOR
POLARIS

NEW
TAN
XS-4XL
2862472



ALTITUDE

509 ALTITUDE 2.0 HELMET

LIGHTWEIGHT DESIGN, PERFORMANCE-INFUSED STYLE AND FEATURES WITH ALL-DAY COMFORT

SHELL

- Strong, lightweight construction of carbon fiber or fiberglass

WEIGHT

- Composite as low as 1,260g
- Carbon fiber as low as 1,150g

FEATURES

- Superior fit for all-day comfort
- Removable Pro Series breath box provides excellent ventilation and air flow
- One-piece eyepoint creates draft-free seal with 509 goggles
- Magnetic Fidlock chin-strap technology and integrated GoPro mount
- DOT- and ECE 22.05-approved

FIDLOCK



BLACK
XS-4XL
2861469

BLACK/RED
XS-4XL
2861472

RED/BLACK
XS-4XL
2861470

CARBON FIBER
BLACK/LIME
XS-4XL | 2861473



LIME
XS-2XL
2861559

TENACITY

TENACITY 4.0 HELMET

COMBINATION OF MODERN STYLE AND PREMIUM PROTECTION WITH INCREDIBLE VALUE

SHELL

- Shock-resistant, injection-molded thermoplastic

WEIGHT

- 1,500g

FEATURES

- Through-flow, full-helmet ventilation
- ProClip quick release chin strap allows you to fasten the chin strap in seconds
- Removable breath box
- Tool-less adjustable roost shield
- Removable, washable liner
- DOT- and ECE 22.05-approved



BLACK
XS-2XL
2861557

BLACK/GRAY
XS-2XL
2861558

BLACK/WHITE
XS-2XL
2861560

WHITE/RED
XS-2XL
2861561

PINK
XS-2XL
2861562

FOR
POLARIS

RED/BLACK
XS-4XL
2862467



TACTICAL

TACTICAL 2.0 HELMET

BUILT FROM THE GROUND UP WITH INNOVATIVE FEATURES FOR ULTIMATE COMFORT AND CONTROL

SHELL

- Shock-resistant, injection-molded thermoplastic

FEATURES

- Venturi vent system generates negative pressure at velocity and pulls moist air from the breath box
- Integrated eyepoint seal is co-integrated with the breath box and creates a draft-free seal with 509 goggles for unparalleled warmth and clear field of view
- Magnetic Fidlock chin-strap technology
- DOT- and ECE 22.06-approved

FIDLOCK



MATTE BLACK
XS-4XL
2862468

GRAY
XS-4XL
2862469

LIME
XS-4XL
2862470

ORANGE
XS-4XL
2862471

GOGGLES



ORANGE
2862561

LIME
2862559

509 KINGPIN OFF-ROAD GOGGLE

PREMIUM MATERIALS, ATTRACTIVE PRICE



FEATURES

- Oversized spherical lens delivers optimal peripheral vision
- Metal tear-off posts provide strength and durability
- Quick-change technology allows you to run the best lens tint for conditions

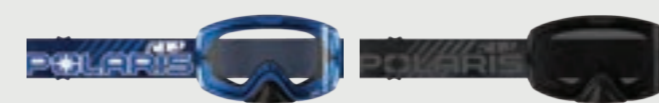

BLUE
2862562

STEALTH
2862560

509 MX6 OFF-ROAD GOGGLE

SUPER WIDE FIELD OF VIEW, ENGINEERED FOR DIRT



FEATURES

- PC outer lens with anti-scratch coating, and internal anti-fog coating
- Outriggers with latch system for quick lens change
- 45mm strap with silicone to hold strap in place



BLACK
2862557

RED/BLACK
2862558

APPAREL

RACING COLLECTION

RIDING GEAR

HELMETS & GOGGLES

MEN'S APPAREL

WOMEN'S APPAREL

MERCHANDISE

MEN'S APPAREL

BLACK
S-3XL | 2862569



NAVY
S-3XL | 2862570

NEW WORK VEST

RUGGED AND DURABLE VEST THAT'S IDEAL AS AN OUTDOOR LAYER

- Coated with Durable Water Repellency (DWR) to provide water-resistance
- 3M Thinsulate for added warmth with brushed flannel trim
- Three outer pockets for storage



CHARCOAL
S-3XL | 2860865



BRONZE
S-3XL | 2860864

FLANNEL JACKET

SHERPA FLEECE LINED JACKET DELIVERS EXCEPTIONAL WARMTH AND COMFORT

- Warm sherpa lined fleece material
- Insulation to keep you warm
- Plenty of storage for your valuables



FOREST GREEN
S-3XL | 2860862



GRAY
S-3XL | 2860863



BLACK
S-3XL | 2861608

WORK JACKET

WARM AND RUGGED JACKET THAT'S TOUGH FOR WORK AND STYLISH FOR PLAY

- Coated with Durable Water Repellency (DWR) to provide water-resistance
- Built in action back for increased range of motion
- 80g 3M Thinsulate for added warmth with brushed flannel trim
- One inner and four outer pockets for storage

SOFTSHELL JACKET

VERSATILE LIGHTWEIGHT JACKET THAT'S SURPRISINGLY WARM AND PERFECT FOR EVERYDAY WEAR

- Casual jacket armed with rugged and warm features for everyday wear
- Superior DWR prevents precipitation from saturating the jacket's exterior
- Lined with 280g of soft fleece for warmth
- Removable hood and underarm venting, three external pockets and one internal chest pocket

BLACK
S-3XL | 2861434



GRAY
S-3XL | 2861435



NEW REVOLVE VEST

REVERSIBLE

DURABLE AND WARM REVERSIBLE VEST OFFERS TWO STYLES IN ONE

- Durable windbreak outer fabric helps protect from the elements
- 140g 3M Thinsulate insulation keeps you warm in cold weather
- Reversible vest offers two unique styles in one



BLUE/ORANGE
S-3XL | 2862566

BLACK/GRAY
S-3XL | 2862565



NEW WINDBREAKER JACKET

LIGHTWEIGHT, WINDPROOF JACKET THAT PROVIDES PROTECTION WHILE RIDING

- 100% polyester windproof fabric
- Lightweight construction makes it easy to pack
- Three external pockets allow for maximum storage

Black | S-3XL | 2861541



FORCE JACKET

PACKABLE JACKET OFFERS LIGHTWEIGHT PROTECTION, IDEAL FOR ANY ACTIVITY

- 140g 3M Thinsulate
- Plenty of storage with two external hand pockets and one internal media pocket
- Rugged YKK zippers
- Great for travel, compacts into pocket

Black | S-3XL | 2861432



APPAREL

RACING COLLECTION

RIDING GEAR

HELMETS & GOGGLES

MEN'S APPAREL

WOMEN'S APPAREL

MERCHANDISE

NEW

TITAN MID-LAYER

EXTREMELY WARM YET BREATHABLE MID-LAYER, PERFECT FOR RIDING

- 319g Polartec Thermal Pro rib sweater provides great warmth
- Quick drying moisture wicking helps keep you dry
- Breathable material moves sweat to the outer surface
- Nylon overlay is comfortable and light

BLUE/ORANGE
S-3XL | 2862567

BLACK
S-3XL | 2862568



NEW
TAN
S-3XL | 2862450

RED/BLACK
S-3XL | 2862490



NORTHSTAR MID-LAYER

VERSATILE MID-LAYER CAN BE WORN ALONE OR AS AN EXTRA LAYER

- 280g of breathable fleece for added warmth
- Offers durable protection against the elements with a wear-resistant polyester face and wind-block layer on chest
- Designed to fit under outer shell when riding

BLACK/RED
S-3XL | 2862616

BLACK/GRAY
S-3XL | 2869925



NEW

JOURNEY HOODIE

DURABLE HOODIE DESIGNED FOR EVERY DAY WEAR

- Keeps the elements out with snug, rib-knit waist and cuffs
- Mock neck collar provides added protection and warmth
- Durable blended material made of 80% cotton, 20% polyester

BLACK
S-3XL | 2862489

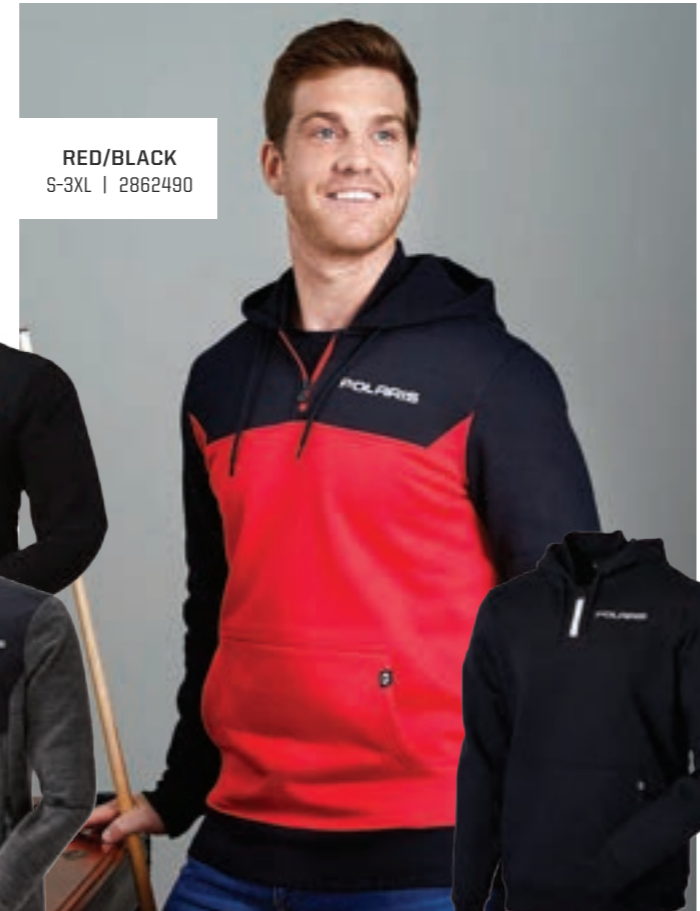

TECH FULL-ZIP HOODIE

NEW Tan | S-3XL | 2862486
Gray | S-3XL | 2861493
Black/Blue | S-3XL | 2861494



CREW SWEATSHIRT

NEW Black | S-3XL | 2862488
Green | S-3XL | 2861498
Navy | S-3XL | 2861497



ICON HOODIE

NEW Gray | S-3XL | 2862487
Green | S-3XL | 2861495
Black | S-3XL | 2861496



ICON LONG SLEEVE

NEW Gray/Red | S-3XL | 2862505
Black | S-3XL | 2861584
Blue | S-3XL | 2861585



DASH LONG SLEEVE

NEW Gray | S-3XL | 2862504
Navy | S-3XL | 2861583
Black | S-3XL | 2861582



CHECKERED LONG SLEEVE

NEW Red | S-3XL | 2862506
Gray | S-3XL | 2861587
Black | S-3XL | 2861586



ICON TEE

NEW Green | S-3XL | 2862501
Black | S-3XL | 2861570
Blue | S-3XL | 2861571



STAMP TEE

NEW Black | S-3XL | 2862496
Gray | S-3XL | 2861565
Green | S-3XL | 2861564



CORE TEE

NEW Red | S-3XL | 2862502
Black | S-3XL | 2861572
Blue | S-3XL | 2861573

MEN'S CAMO

STEALTH CAMO HAT

Camo | One Size | 2861527



NORTHSTAR MID LAYER

Camo | S-3XL | 2861542



CAMO SOFTSHELL JACKET

Camo | S-3XL | 2861543

MEN'S BALL CAPS



ELLIPSE PATCH TRUCKER HAT

NEW Light Gray | One Size | 2862539
 Gray | One Size | 2861531
 Black | One Size | 2861533
 Navy | One Size | 2861532

NEW HIGHLAND CAP

Tan | One Size | 2860893
 Gray | One Size | 2862544



NEW CAMO REVOLVE VEST

Camo | S-3XL | 2862572



NEW PURSUIT HOODIE

Camo | S-3XL | 2862494



CAMO NECK GAITER

Camo | One Size | 2861948



CAMO TRUCKER HAT

Black | One Size | 2860613



HUNTER ORANGE HAT

Orange | S/M | 2860892
 Orange | L/XL | 2862545



HUNTER ORANGE BEANIE

Orange | One Size | 2862595



CORE CAP

NEW Gray | One Size | 2862594
 Navy | One Size | 2861523
 Black | One Size | 2861524



TONAL HAT

Black/Red | One Size | 2861526
 Navy | One Size | 2861525



NEW CLASSIC CAP

Gray | One Size | 2862543
 Navy | One Size | 2862597



CHECKERED HAT

Blue | One Size | 2861520
 Black | One Size | 2861522
 Gray | One Size | 2861521



RETRO CAP

NEW Navy | One Size | 2862538
 Gray/Red | One Size | 2869542
 Gray/Orange | One Size | 2861536

WOMEN'S APPAREL

NEW
BLUE
S-3XL | 2862460

BLACK
S-3XL | 2862563



BLACK
S-3XL | 2861437

GRAY/BLUE
S-3XL | 2861439

BLUE
S-3XL | 2862564

SOFTSHELL JACKET

LIGHTWEIGHT PERFORMANCE THAT'S SURPRISINGLY WARM AND PERFECT FOR EVERYDAY WEAR

- Superior DWR prevents precipitation from saturating the jacket's exterior
- Lined with 280g of soft fleece for warmth
- Removable hood and underarm venting, three external pockets and one internal chest pocket



BLACK
S-3XL | 2862457

DUSTY ROSE
S-3XL | 2862456

BLACK
S-3XL | 2861433

NEW REVOLVE VEST

DURABLE AND WARM REVERSIBLE VEST OFFERS TWO STYLES IN ONE

- Durable windbreak outer fabric protects you from the elements
- 140g 3M Thinsulate insulation keeps you warm in cold weather
- Reversible vest offers two unique styles in one

FORCE JACKET

PACKABLE JACKET OFFERS LIGHTWEIGHT PROTECTION, IDEAL FOR ANY ACTIVITY

- 140g 3M Thinsulate
- Plenty of storage with two external hand pockets and one internal media pocket
- Rugged YKK zippers
- Great for travel, compacts into pocket

NEW WORK JACKET

WARM AND RUGGED JACKET THAT'S TOUGH FOR WORK AND STYLISH FOR PLAY

- Coated with DWR to provide water-resistance
- Built-in action back for increased range of motion
- 80g 3M Thinsulate for added warmth with brushed flannel trim
- One inner and four outer pockets for storage



BLACK/GRAY
S-3XL | 2862458

DUSTY ROSE
S-3XL | 2862459

TITAN MID-LAYER

EXTREMELY WARM YET BREATHABLE MID-LAYER, PERFECT FOR RIDING

- 319g Polartec Thermal Pro rib sweater provides great warmth
- Quick drying moisture wicking helps keep you dry
- Breathable material moves sweat to the outer surface
- Nylon overlay is comfortable and light



NEW
PURSUIT HOODIE
Camo | S-3XL | 2862517



NEW JOURNEY HOODIE

Black | S-3XL | 2862515
Blue | S-3XL | 2862516

TECH FULL-ZIP HOODIE

Maroon | S-3XL | 2861509
Gray | S-3XL | 2861508

ICON HOODIE

NEW White | S-3XL | 2862512
Black | S-3XL | 2861506
Maroon | S-3XL | 2861507



NEW ADVENTURE CREW

Dusty Rose | S-3XL | 2862513
Black | S-3XL | 2862514

NEW ADVENTURE TEE

Teal | S-3XL | 2862629
Black Frost | S-3XL | 2862628

THINK OUTSIDE TEE

NEW Pink | S-3XL | 2862518
Black | S-3XL | 2861590
Blue | S-3XL | 2861591

APPAREL

RACING COLLECTION

RIDING GEAR

HELMETS & GOGGLES

MEN'S APPAREL

WOMEN'S APPAREL

MERCHANDISE

MERCHANDISE



STEEL SIGN

35.6 cm x 91.4 cm | 2860868



ALUMINUM SIGN

55.9 cm | 2860867



WOOD SIGN

26.7 cm x 61 cm | 2860866



PINT GLASSES (SET OF 2)

2860815



12oz CAMPER MUG

2861612



17oz WATER BOTTLE

2861611



23oz WATER BOTTLE

2862685



15oz CAMPFIRE MUG

2861613



KEYCHAIN

2861614



LEATHER LOOP KEYCHAIN

2861615



LICENSE PLATE HOLDER

2862687



NEW
KICKBACK ROCKER

2862626



NEW
FREESTYLE ROCKER

2862625



NEW
EASY CHAIR

2862627



NEW
QUICK-E-SEAT

2862624



NEW
FOLDING TABLE

2861620



NEW
POLARIS PARKING SIGN

2869934



NEW
POLARIS FLAG

91.4 cm x 152.4 cm | 2869928



NEW
HITCH COVER

2861623



APPAREL

RACING COLLECTION

RIDING GEAR

HELMETS & GOGGLES

MEN'S APPAREL

WOMEN'S APPAREL

MERCHANDISE

FORGE YOUR OWN PATH



AVAILABILITY VARIES BY MARKET, CHECK YOUR LOCAL DEALER FOR AVAILABILITY. IMAGE TAKEN ON PRIVATE LAND. THE USE OF VEHICLES IN SIMILAR ENVIRONMENTS IN YOUR JURISDICTION MAY BE PROHIBITED PER LOCALLY APPLICABLE LAWS AND REGULATIONS. CAMPFIRE IN SIMILAR ENVIRONMENTS IN YOUR JURISDICTION MAY BE PROHIBITED PER LOCALLY APPLICABLE LAWS AND REGULATIONS. KEEP YOUR CAMPFIRE SAFE, AND MAKE SURE YOU CAN CONTROL IT AT ALL TIMES. KNOW YOUR LOCALLY APPLICABLE LAWS AND REGULATIONS. CROSSING WATER IN SIMILAR ENVIRONMENTS MAY BE PROHIBITED IN YOUR JURISDICTION.

WARNING: POLARIS OFF-ROAD VEHICLES CAN BE HAZARDOUS TO OPERATE AND ARE NOT INTENDED FOR ON-ROAD USE. DRIVER MUST BE AT LEAST 16 YEARS OLD WITH A VALID DRIVER'S LICENSE TO OPERATE. ALL RIDERS SHOULD ALWAYS WEAR HELMETS, EYE PROTECTION AND PROTECTIVE CLOTHING AND FOOTWEAR. READ, UNDERSTAND AND FOLLOW YOUR OWNER'S MANUAL. RIDE WITHIN THE LIMITS OF YOUR OWN ABILITIES AND NEVER ENGAGE IN STUNT OR EXHIBITION DRIVING. NEVER RIDE UNDER THE INFLUENCE OF DRUGS OR ALCOHOL. ALL RIDERS SHOULD TAKE A SAFETY TRAINING COURSE. CALL 800-342-3764 FOR ADDITIONAL INFORMATION.

Unless noted, trademarks are the property of Polaris Industries Inc. 3M® and Thinsulate® are registered trademarks of 3M Company. 509® is a registered trademark of Teton Outfitters, LLC. App Store® is a registered trademark of Apple Inc. BatteryMinder® is a registered trademark of VDC Electronics Inc. Bluetooth® is a registered trademark of Bluetooth Sig, Inc. Caliber® is a registered trademark of Caliber, Inc. CAMSO® is a registered trademark of Artic Investments S.A. COOLCORE® is a registered trademark of COOLCORE LLC. Facebook® is a registered trademark of Facebook, Inc. FidoLock® is a registered trademark of FidoLock GmbH. Google Play® is a registered trademark of Google, Inc. Instagram® is a registered trademark of Instagram, LLC. Kolpin® is a registered trademark of Polaris Industries Inc. Polartec® is a registered trademark of MMI-TPCO, LLC. RIGID® is a trademark of JST Performance, LLC d/b/a Rigid Industries, LLC. Rockford Fosgate® is a registered trademark of Rockford Corporation. SMART BOARD® is a registered trademark of MART TECHNOLOGIES ULC UNLIMITED LIABILITY CORPORATION CANADA. TEKVEST® is a registered trademark of 1181676 ONTARIO INC. Tiger Drylac® is a registered trademark of TIGER COATINGS GMBH & CO. KG. Velcro® is a registered trademark of VELCRO BVDA. Twitter® is a registered trademark of Twitter, Inc. WALKER EVANS RACING® is a registered trademark of Walker Evans Enterprises Incorporated. Yeti® is a registered trademark of Yeti Coolers, LLC. YKK® is a registered trademark of YKK Corporation. YouTube® is a registered trademark of Google Inc. Prices, Fitment and Availability are subject to change at any moment. Copyright © 2021 Polaris Industries Inc. All rights reserved.

POLARIS

MY22 SPTSMN APP ACC EMEA